



D61EXi-23 D61PXi-23

Tier 4 Interim Engine

D
6
1
i

**3D GNSS
MACHINE
CONTROL**

NET HORSEPOWER
168 HP @ 2200rpm
125 kW @ 2200rpm

OPERATING WEIGHT
D61EXi-23 17890 kg 39,441 lb
D61PXi-23 18770 kg 41,381 lb

BLADE CAPACITY
4.5–5.1 yd³
3.4–3.9 m³



PHOTOS MAY INCLUDE OPTIONAL EQUIPMENT



INTRODUCING THE D61i-23

Komatsu D61PX-23 With Typical
Aftermarket Machine Control System



We've Made Great, Greater

Customer Driven Solutions, For Your Machine Control Needs

D61i-23

Introducing The Next Generation Of Machine Control

>> **D61EXi-23**

Innovative

Automated operation from
rough dozing to finish grade.

>> **D61PXi-23**

Intelligent

New dozing mode, load
control performance features.

Integrated

Standard factory installed
integrated system.



No Cables

No coiled cables between
machine and blade.

No Climbing

GNSS antenna and mast
removed from blade.

No Connections

No daily connections
required between
machine and blade.

Photos may include optional equipment

D61i-23

Tier 4 Interim Engine

NET HORSEPOWER

125 kW @ 2200 rpm
168 HP @ 2200 rpm

OPERATING WEIGHT

D61EXi-23 17890 kg 39,441 lb
D61PXi-23 18770 kg 41,381 lb

BLADE CAPACITY

Power Angle Tilt Dozer
D61EXi-23 3.4 m³ 4.5 yd³
D61PXi-23 3.9 m³ 5.1 yd³



INNOVATIVE. INTEGRATED. INTELLIGENT.

Standard Intelligent Machine Control

Standard factory installed integrated 3D GNSS intelligent machine control system.

Improved Machine Control

Up to 13% more efficient dozer operation than comparable aftermarket machine control systems in start to finish grading tests.

Factory Installed Machine Control Components

Machine control components are factory installed and designed as an integral part of the base machine for improved durability.

Komatsu Quality

Machine control components and system validated to Komatsu's rigorous quality & durability standards.

Industry Standard Compatibility

Machine control system makes use of common industry design data file norms and supports typical base station communication.

Simple Operator Interface

Simple touch screen control box with multi-color customizable display.

3D GNSS Machine Control Standard

All on-machine components standard including control box, GNSS receiver/radio, GNSS antenna, and enhanced inertial measuring unit sensor.

Finish Grade Performance

Enhanced sensor package and intelligent logic provides for finish grade accuracy in an integrated system without traditional blade mounted sensors.

Stroke Sensing Hydraulic Cylinders

Robust stroke sensing hydraulic cylinders employ proven Komatsu sensor technologies for accurate finish grade performance.

Enhanced Inertial Measuring Unit (IMU+)

Chassis mounted enhanced inertial measuring unit (IMU+) and intelligent logic provides for finish grade accuracy without blade mounted sensors.

Cab Top GNSS Antenna

No blade mounted GPS antennas, cables to worry about damaging with cab top GNSS antenna.

Automatic Dozing From Start To Finish

Load control intelligence controls blade elevation to improve productivity and minimize track slip by adjusting blade load. 1.0' from grade or 0.1' from grade – you can run in auto mode.

Intelligent Dozing Mode Settings

Operators are able to select between 4 distinct machine control operating modes to optimize performance to the application whether cutting, spreading, or other.

Operator Selectable Load Settings

Machine control load settings can be adjusted between presets to tailor response to material conditions.

KOMTRAX®

Komtrax equipped machines can send location, SMR and operation maps to a secure website utilizing wireless technology. Machines also relay error codes, cautions, maintenance items, fuel levels, and much more.



D61i-23

INTELLIGENT MACHINE CONTROL



Factory Integrated Sensor Package

Typical blade mounted components are replaced with factory installed cab top GNSS antenna, enhanced inertial measuring unit (IMU+), and stroke sensing hydraulic cylinders. Komatsu durability & quality with factory installation, integration.

Cab Top GNSS Antenna

No blade mounted GNSS antenna(s), cables to worry about damaging with cab top GNSS antenna. Reduced risk of theft due to low visibility as viewed from ground level.

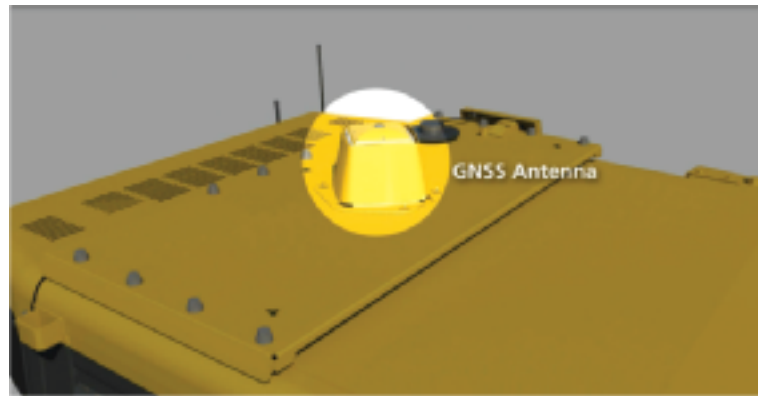

Enhanced Inertial Measuring Unit (IMU+)

Chassis mounted enhanced inertial measuring unit (IMU+) and intelligent logic provides for finish grade accuracy without blade mounted sensors. Positional updates up to 100Hz.

Stroke Sensing Hydraulic Cylinders

Robust stroke sensing hydraulic cylinders employ proven Komatsu sensor technologies for accurate finish grade performance. Stroke sensing angle cylinder allows machine control system to know the angle of the blade.

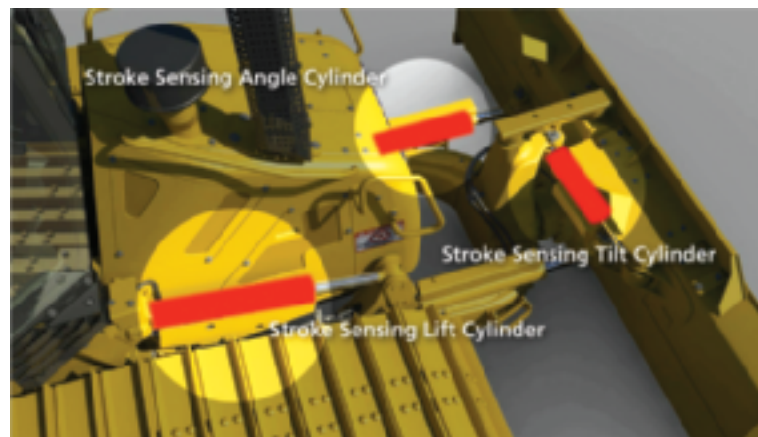

D61i-23



Operator Selectable Load Settings

Machine control load settings can be adjusted between presets to tailor response to material conditions. From dry loose sandy soils to wet heavy clay materials, system performance can be targeted accordingly.

Improved Machine Control Efficiency

Up to 13% more efficient dozer operation than typical aftermarket machine control systems with Komatsu's intelligent machine control. This is on top of already large time savings that standard machine control offers over manual staking & grading.



As-Built Surface Track Mapping

Cab top GNSS antenna provides for accurate as-built surface data collection by measuring actual elevations as machine continuously tracks in operation. Progress can be measured in real time with operator selectable settings.

Standard Touch Screen Control Box

Factory installed and features simple, easy to use operator interface. Mounted high for excellent visibility, viewing angle is adjustable per operator preference.



PRODUCTIVITY & ECOLOGY FEATURES

D61i-23

Environment-Friendly Engine

The Komatsu SAA6D107E-2 engine is EPA Tier 4 Interim and EU Stage 3B emissions certified and provides exceptional performance while reducing fuel consumption. Based on Komatsu proprietary technologies developed over many years, this new diesel engine reduces exhaust gas particulate matter (PM) by more than 90% and nitrogen oxide (NOx) by more than 45%, compared to Tier 3 levels. Through the in-house development and production of engines, electronics, and hydraulic components, Komatsu has achieved great advancements in technology providing high levels of performance and efficiency in virtually all applications.

Komatsu Variable Geometry Turbocharger (KVGIT)

Using Komatsu proprietary technology, a newly designed variable geometry turbocharger with a hydraulic actuator is used to manage and deliver optimum air flow to the combustion chamber under all speed and load conditions. The robust hydraulic actuator provides power and precision, resulting in cleaner exhaust gas and improved fuel economy while maintaining performance.

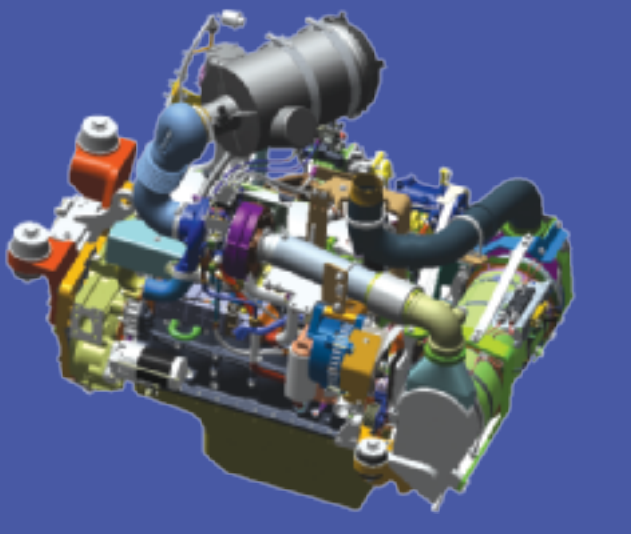
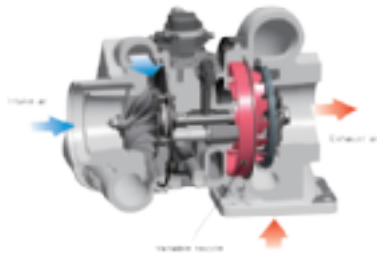

Advanced Electronic Control System

The engine control system has been upgraded to effectively manage a variety of parameters such as the air flow rate, EGR gas flow rate, fuel injection parameters, and aftertreatment functions. The new control system also provides enhanced diagnostic capabilities.

Cooled Exhaust Gas Recirculation (EGR)

Cooled EGR, a technology that has been well proven in Komatsu Tier 3 engines, reduces NOx emission to meet Tier 4 levels. The hydraulically-actuated EGR system has increased capacity and uses larger and more robust components to ensure reliability for demanding work conditions.

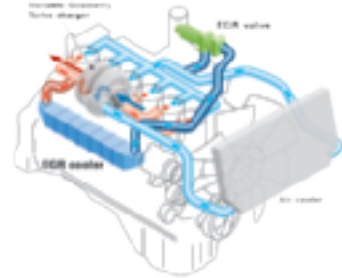

Redesigned combustion chamber

The combustion chamber has a new shape designed to improve combustion and further reduce NOx, PM, fuel consumption, and noise levels.

Closed Crankcase Ventilation (CCV)

Crankcase emissions (blow-by gas) are passed through a CCV filter. The CCV filter traps oil mist which is returned back to the crankcase while the filtered gas is returned to the air intake.

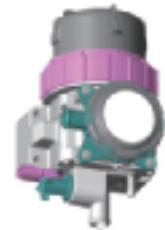

High efficiency fuel filter

A new high efficiency fuel filter improves fuel system reliability. The dual-type filter offers twice the filtration capacity.



HST Technology

The D61i-23 incorporates new proprietary engine and hydrostatic transmission pump control technology to improve operational efficiency and reduce fuel consumption to levels lower than a conventional HST control system can obtain. This Komatsu exclusive feature reduces fuel consumption by up to 10% in P mode in demanding working conditions and up to 20% in E mode under lighter load conditions as compared to the prior model.

Powerful turns under various work conditions are achieved with the HST transmission, even under load. Counter-rotation is available for minimum turning radius, providing excellent maneuverability in tight spots.

Variable and Customizable Quickshift Modes

The D61i-23 offers two gearshift modes: Variable and the new Customizable Quick shift. Variable shift mode provides 20 incremental speed settings for the operator, while the Customizable Quick shift provides 3 speed settings; all can be adjusted in the monitor to obtain the right speed for different operator preferences.

Single Pedal (Decelerator/Brake Pedal) to be operated for Speed Control, during Operation

Machine operation becomes simple because the brake function has been integrated into the decelerator pedal. Machine moving speed including/excluding engine speed can be controllable by using only one pedal of decelerator/brake pedal. Operation of pedal function can be changed by the mode selector switch.

**Decelerator mode**

The pedal can decelerate engine RPMS and vehicle travel speed. Normally can be used for all applications.

Brake mode

The pedal can decelerate vehicle travel speed, keeping high engine revolution. This mode can be helpful to keep work equipment controllability and/or force, even during braking.



Komatsu Diesel Particulate Filter (KDPF)

Komatsu has developed a high efficiency diesel particulate filter that captures more than 90% of particulate matter. Both passive and active regeneration are automatically initiated by the engine controller depending on the soot level of the KDPF. A special oxidation catalyst with a fuel injection system is used to oxidize and remove particulate matter while the machine is running so the regeneration process will not interfere with daily operation. The operator can also initiate regeneration manually or disable regeneration depending on the work environment.

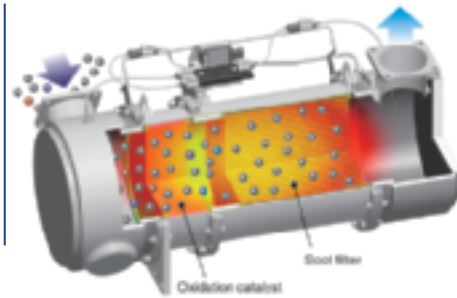

KDPF Regeneration Notification

The LCD color monitor panel provides the operator with the status of the KDPF regeneration without interfering with daily operation. When the machine initiates active regeneration, an icon will notify the operator.



Selectable Working Mode

Working mode E is for general dozing applications with adequate speed and power while reducing fuel consumption and CO₂. Working mode P is aimed at powerful operation and maximum production. The working mode is easily switched on the monitor panel, depending on the work at hand.



Manual Stationary Regeneration

Under most conditions, active regeneration will occur automatically with no effect on machine operation.

In case the operator needs to disable active regeneration or initiate a manual stationary regeneration, such as in high-combustible applications, this can be easily accomplished through the monitor panel.

The soot level indicator identifies how much soot is trapped in the KDPF.



▪ **E mode (Economy mode)**

With E mode, the engine outputs enough power for most general dozing applications without delivering unnecessary power. This mode allows for energy-saving operation and is suitable for work on ground where the machine may experience shoe slip or applications not requiring large power such as downhill dozing, leveling and light-load work.

▪ **P mode (Power mode)**

With P mode, the engine outputs its full power, allowing the machine to perform large production, heavy-load, or uphill work.



Other Features

Power Angle Tilt (PAT) Dozer With Adjustable Pitch

A Power Angle Tilt dozer blade with highly durable box-structure frame is available for the EX and PX machines. The hydraulic blade tilt and angling functions and manually adjustable blade pitch expand versatility and productivity in a variety of applications. This PAT dozer assembly is tested to stringent test standards.



Secondary Engine Shutdown Switch

A secondary switch has been added at the side of the front console to shut down the engine.



Standard Rear Hydraulics

Standard rear hydraulics for rear attachment installation.

ECO Guidance

In order to support to optimum operation, the following four recommendations are displayed to improve fuel saving operation:

- 1) Avoid Excessive Engine Idling
- 2) Use Economy Mode to Save Fuel
- 3) Avoid Hydraulic Relief Pressure
- 4) Avoid Overload



The operator can access the ECO guidance menu to check the Operation Records, Eco Guidance Records, and Average Fuel Consumption logs.

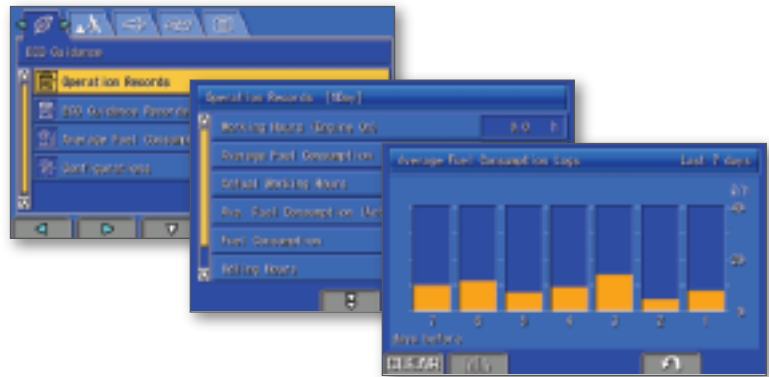

Rear View Monitoring System

On the large LCD color monitor, the operator can view areas directly behind the machine through one camera.

This camera can be synchronized with reverse operation.



Integrated ROPS Cab

The cab; wider, deeper and taller, is integrated with the ROPS. High rigidity and superb sealing performance greatly reduce noise and vibration for the operator and minimize dust entering the cab. Larger glass area improves visibility of the blade, sides, and rear of the machine. Cab meets ROPS and FOPS Level 2 standards.



Palm Command Control System (PCCS) Travel Joystick

Palm command travel joystick provides the operator with a relaxed posture and superb fine control. Transmission shifting is simplified with thumb push buttons.



Electronic Controlled Hydraulic System (EPC) Blade Control Joystick

Blade control joystick uses the EPC valve and joystick, similar to the travel control joystick.



EPC control combined with the highly reliable Komatsu hydraulic system enables superb fine control. A switch is used to angle the PAT blade. A button to activate float is also provided.

High Capacity Air Suspension Seat

A higher capacity low-back heated seat with headrest is standard. The seat has many adjustments to accommodate different operators comfortably.



Auxiliary Input Jack

By connecting an auxiliary device to this plug input, the operator can hear sound through the speakers installed in the cab.



Large Multi-Lingual LCD Color Monitor

A large user-friendly color monitor enables accurate and smooth work. Excellent screen visibility is achieved by the use of a TFT liquid crystal display that can easily be read at various angles and lighting conditions. Simple and easy to operate switches facilitate multi-function operations. Data can be displayed in 25 languages for local customization.

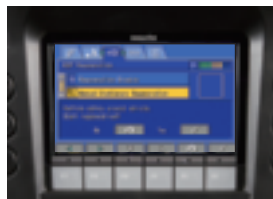

MAINTENANCE & DURABILITY FEATURES

Planned maintenance is the best way to ensure long service life from your equipment. That's why Komatsu designed the D61i-23 with conveniently located maintenance points to make necessary inspections and maintenance quick and easy.

Hydraulically-Driven Swing-up Fan

The D61i-23 utilizes a swing-up fan with a gas strut-assisted lift locking system to provide easy access to the (side-by-side) radiator, oil cooler, and charge air cooler. The swing-up feature makes it easier to access cooling cores. The hydraulic fan has a "cleaning" mode. The fan rotates in the reverse direction and helps to clear off objects in front of the cooling areas.



Photos may include optional equipment

Daily Checks

All daily checks can be performed efficiently from the left side of the machine.



Photos may include optional equipment

Robust Guarding And Attachments

Komatsu offers a full guarding package to help protect your investment in severe applications.

Parallel Link Undercarriage System (PLUS)

Komatsu's new Parallel Link Undercarriage System (PLUS) provides less downtime plus longer wear life with up to 40% lower undercarriage maintenance costs. Rotating bushings eliminate the cost and downtime for bushing turns, and strengthened rollers and links increase wear life up to two times. With PLUS, individual links can be replaced with common track tools.



Self-Adjusting Idler Support

The self-adjusting idler support provides constant and even tension on idler guide plates reducing noise and vibration and increasing undercarriage life.

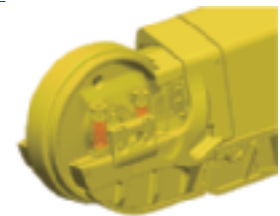

Modular Design

One of the design goals behind the creation of the D61i-23 was to manufacture a more durable machine. This was achieved by reducing component complexity and using a strong modular design for increased serviceability and durability. Steel castings reduce the number of welds, improving C-frame rigidity and strength.

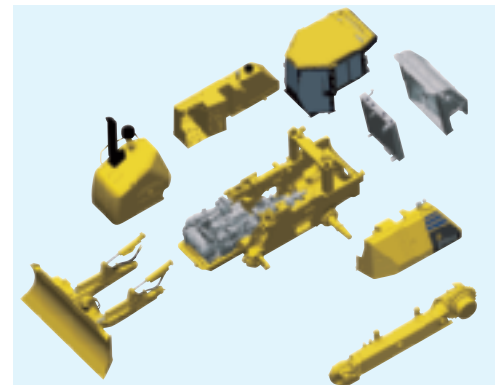



Komatsu CARE – Complimentary Scheduled Maintenance

- PM services for the earlier of 3 years / 2,000 hours
- Performed by factory certified technicians
- Komatsu Genuine parts and fluids
- Significantly lowers your cost of ownership while maintaining high uptime and reliability
- Increases resale value and provides detailed maintenance records
- Extended PM services can be purchased beyond the complimentary period to provide additional peace of mind and maximize uptime



Komatsu CARE – Extended Coverage

- Extended Coverage can provide peace of mind by protecting customers from unplanned expenses that effect cash flow
- Purchasing extended coverage locks-in the cost of covered parts and labor for the coverage period and helps turn these into fixed costs



Komatsu Parts Support

- 24/7/365 to fulfill your parts needs
- 9 parts Distribution Centers strategically located across the U.S. and Canada
- Distributor network of more than 300 locations across U.S. and Canada to serve you
- Online part ordering through Komatsu eParts
- Remanufactured components with same-as-new warranties at a significant cost reduction



Komatsu Oil and Wear Analysis (KOWA)

- KOWA detects fuel dilution, coolant leaks, and measures wear metals
- Proactively maintain your equipment
- Maximize availability and performance
- Can identify potential problems before they lead to major repairs
- Reduce life cycle cost by extending component life

KOMTRAX EQUIPMENT MONITORING

GET THE WHOLE STORY WITH
KOMTRAX[®]

✓ WHAT

- KOMTRAX is Komatsu's remote equipment monitoring and management system
- KOMTRAX **continuously monitors and records** machine health and operational data
- Information such as fuel consumption, utilization, and a detailed history **aids in making repair or replacement decisions**

✓ WHEN

- Know when your machines are **running or idling** and make decisions that will improve your fleet utilization
- Detailed movement records ensure you know when and where your equipment is moved
- Up to date records allow you to **know when maintenance was done** and help you plan for future maintenance needs

✓ WHERE

- KOMTRAX data **can be accessed virtually anywhere** through your computer, the web or your smart phone
- Automatic alerts keep fleet managers up to date on the latest machine notifications

✓ WHY

- Knowledge is power - **make informed decisions** to manage your fleet better
- Knowing your idle time and fuel consumption will help maximize your machine efficiency
- **Take control of your equipment** - any time, anywhere

✓ WHO

- KOMTRAX is **standard** equipment on all Komatsu construction products



Monthly Operational Analysis



Fuel Consumption Reports

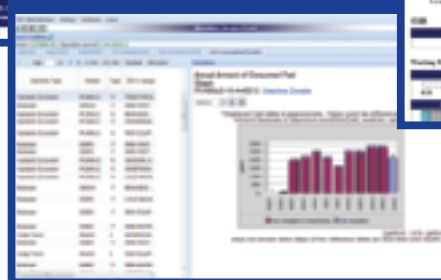

KOMTRAX[®]

For construction and compact equipment.

KOMTRAX Plus

For production and mining class machines.



ENGINE

Model..... Komatsu SAA6D107E-2*
 Type..... 4-cycle, water-cooled, direct injection
 Aspiration..... Komatsu variable geometry Turbocharged, air-to-air aftercooled
 Number of cylinders..... 6
 Bore x stroke..... 107 mm x 124 mm **4.21" x 4.88"**
 Piston displacement..... 6.69 ltr **408 in³**
 Governor..... All-speed and mid-range, electronic
 Horsepower
 SAE J1995..... Gross 127 kW **170 HP**
 (ISO 14396..... 126 kW **169 HP**)
 ISO 9249 / SAE J1349..... Net 125 kW **168 HP**
 Rated rpm..... 2200 rpm
 Fan drive type..... Hydraulic
 Lubrication system
 Method..... Gear pump, force lubrication
 Filter..... Full-flow
 *EPA Tier 4 Interim and EU stage 3B emissions certified



HYDROSTATIC TRANSMISSION

Dual-path, hydrostatic transmission provides infinite speed changes up to 9.0 km/h **5.6 mph**. The variable capacity travel motors allow the operator to select the optimum speed to match specific jobs. Travel control lock lever and neutral switch.

Travel speed (quick shift mode)*	Forward	Reverse
1st	0-3.4 km/h 0-2.1 mph	0-4.1 km/h 0-2.5 mph
2nd	0-5.6 km/h 0-3.5 mph	0-6.5 km/h 0-4.0 mph
3rd	0-9.0 km/h 0-5.6 mph	0-9.0 km/h 0-5.6 mph

Travel speed (variable mode)	Forward	Reverse
	0-9.0 km/h 0-5.6 mph	0-9.0 km/h 0-5.6 mph

*Quick shift speeds are adjustable in the monitor.

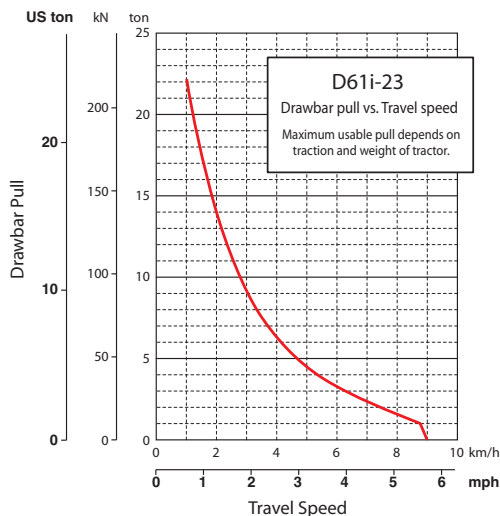

FINAL DRIVES

In-shoe mounted axial piston type travel motors with integrated two-stage planetary gear reduction. Compact in-shoe mount reduces risk of damage by debris. Bolt-on sprocket teeth for easy displacement.



STEERING SYSTEM

Palm Command Control System (PCCS) joystick control for all directional movements. Pushing the joystick forward results in forward machine travel, while pulling it rearward reverses the machine. Simply tilt the joystick to the left or right to make a turn. Tilting the joystick fully to the left or right activates counter-rotation.

Hydrostatic Transmission (HST) provides smooth powerful turns. Fully electronic control enables smooth control that can be adjusted in the monitor. The PCCS utilizes shift buttons to increase and decrease speed.

Minimum turning radius*
 D61EXi-23.....2.1 m **83"**
 D61PXi-23..... 2.3 m **91"**

*As measured by track marks on the ground at pivot turn.



UNDERCARRIAGE

Suspension..... Oscillating-type with equalizer bar and pivot shafts
 Track roller frame..... Monocoque, large section, durable construction

Rollers and idlers..... Lubricated track rollers

Lubricated tracks
 Parallel Link Undercarriage System (PLUS) with lubricated rotating bushings for extended system wear life and lower maintenance costs. Track tension is easily adjusted with grease gun.

	D61EXi-23	D61PXi-23
Number of track rollers (each side)	8	8
Type of shoes (standard)	Single grouser	Single grouser
Number of shoes (each side)	46	46
Grouser height	mm in 57.5 2.3"	57.5 2.3"
Shoe width (standard)	mm in 600 24"	860 34"
Ground contact area	cm ² 31200	54520
	in² 4,836	8,451
Ground pressure (with dozer, ROPS cab)	kPa 56.2	33.8
	kgf/cm ² 0.57	0.34
	psi 8.16	4.90
Track gauge	mm ft.in 1900 6'3"	2130 7'0"
Length of track on ground	mm ft.in 3161 10'5"	3161 10'5"



SERVICE REFILL CAPACITIES

Coolant..... 45 ltr **11.9 U.S. gal**
 Fuel tank..... 372 ltr **98.3 U.S. gal**
 Engine oil..... 27 ltr **7.2 U.S. gal**
 Hydraulic tank..... 101 ltr **26.7 U.S. gal**
 Final drive (each side)..... 8.1 ltr **2.2 U.S. gal**



OPERATING WEIGHT

Tractor weight:
 Including ROPS cab, U frame for power angle tilt dozer, rated capacity of lubricant, coolant, full fuel tank, operator, and standard equipment.

D61EXi-23..... 17810 kg **39,264 lb**
 D61PXi-23..... 18690 kg **41,204 lb**

Operating weight:
 Including Power Angle Tilt dozer, ROPS cab, operator, standard equipment, rated capacity of lubricant, hydraulic control unit, coolant, and full fuel tank.

D61EXi-23..... 17890 kg **39,441 lb**
 D61PXi-23..... 18770 kg **41,381 lb**



DIMENSIONS

	D61EXi-23		D61PXi-23	
A	3250 mm	10'8"	3860 mm	12'8"
B	435 mm	1'5"	515 mm	1'8"
C	1195 mm	3'11"	1155 mm	3'9"
D	1025 mm	3'4"	1025 mm	3'4"
E	580 mm	1'11"	580 mm	1'11"
F	3165 mm	10'5"	3165 mm	10'5"
G	5480 mm	18'0"	5480 mm	18'0"
H	3340 mm	11'0"	3340 mm	11'0"
I	57.5 mm	2"	57.5 mm	2"
J	1900 mm	6'3"	2130 mm	7'0"
K	600 mm	2'0"	860 mm	2'10"
L	2500 mm	8'2"	2990 mm	9'10"
M	2980 mm	9'9"	3530 mm	11'7"
N	6100 mm	20'0"	6220 mm	20'5"

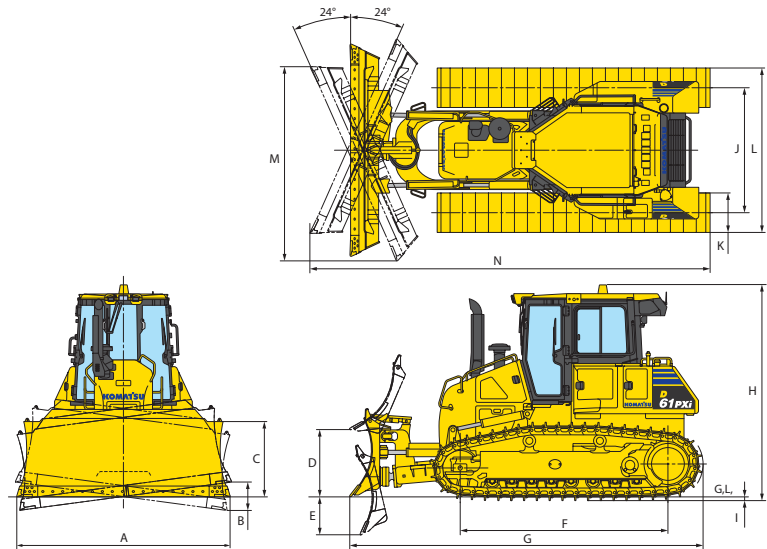

Ground clearance 390 mm **15"**



HYDRAULIC SYSTEM

Closed-center Load Sensing System (CLSS) designed for precise and responsive control, and for efficient simultaneous operation.

Hydraulic control unit:

All spool control valves externally mounted remote to the hydraulic tank. Piston-type hydraulic pump with capacity (discharge flow) of 171 ltr/min **45 U.S. gal/min** at rated engine rpm.

Relief valve setting 27.4 MPa 280 kg/cm² **3,974 psi**
 Hydraulic cylinders..... Double-acting, piston type

	Number of cylinders	Bore
Blade lift	2	100 mm 4"
Blade tilt	1	120 mm 5"
Blade angle	2	110 mm 4"

Hydraulic oil capacity (refill):

Power angle tilt dozer 101 ltr **26.7 U.S. gal**

Control valves:

3-spool control valve for Power Angle Tilt dozer

Positions:

Blade lift Raise, hold, lower, and float

Blade tilt Right, hold, and left

Blade angle Right, hold, and left

Additional control valve required for ripper

Positions:

Ripper lift Raise, hold, and lower



DOZER EQUIPMENT

Blade capacities are based on the SAE recommended practice J1265.

Use of high tensile strength steel in moldboard for strengthened blade construction.

	Overall Length With Dozer mm ft.in	Blade Capacity m ³ yd ³	Blade Width x Height mm ft.in	Max. Lift Above Ground mm ft.in	Max. Drop Below Ground mm ft.in	Max. Tilt Adjustment mm ft.in
D61EXi-23	5480	3.4	3250 x 1195	1025	580	435
Power Angle Tilt Dozer	18'0"	4.5	10'8" x 3'11"	3'4"	1'11"	17"
D61PXi-23	5480	3.8	3860 x 1155	1025	580	515
Power Angle Tilt Dozer	18'0"	5.0	12'8" x 3'9"	3'4"	1'11"	20"



STANDARD EQUIPMENT FOR BASE MACHINE*

- Air cleaner, double element with dust indicator
- Alternator, 90 ampere/24V
- Backup alarm
- Batteries, 200 Ah/2 x 12V
- Battery disconnect switch
- Blade lift cylinders
- Color monitor, LCD
- Decelerator pedal (single pedal)
- Engine hood
- Engine intake centrifugal precleaner
- Engine, swing open side cover
- Engine shutdown secondary switch
- Front pull hook
- High mount foot rests
- Horn, warning
- Hydraulic driven radiator cooling fan with reverse clean mode
- Hydraulics for rear equipment
- Intelligent machine control
- KOMTRAX® Level 4
- Komatsu Diesel Particulate Filter (KDPF)
- Komatsu Variable Geometry Turbocharger (KVGIT)
- Locks, filler caps and covers
- Muffler with curved exhaust pipe
- Radiator mask, heavy-duty, swing up
- Radiator reserve tank
- ROPS cab**
 - Air conditioner
 - Cab accessories
 - 12V power supply (2 ports)
 - Cup holder
 - Rearview mirror
 - Rear view monitoring (1 camera)
 - AM/FM Radio w/remote AUX plug (3.5 mm)
 - 76 dBA
 - Work lights
 - 3 front, cab mounted
 - 2 rear, cab mounted
- Seat, air suspension, fabric, heated low back, headrest
- Seat belt, 76 mm **3"**, retractable
- Seat belt indicator
- Sealed electrical connectors
- Side by side rear mounted cooling package
- Starting motor, 5.5 kW/24V
- Steering system, hydrostatic
- Track roller guards, center and end sections
- Track shoe assembly
 - Heavy-Duty lubricated rotary bushing (PLUS) track
 - 600 mm **24"** single grouser shoe (EX)
 - 860 mm **34"** single grouser shoe (PX)
- Transmission with Variable and Customizable Quickshift
- Transmission, hydrostatic
- Underguards, heavy-duty
 - Engine
 - Transmission
- Water separator

* Dozer assembly and rear mounted equipment are not included in base machine standard equipment
 ** Cab meets ROPS and FOPS Level 2 standards



OPTIONAL EQUIPMENT

- Drawbar, long type
- Track roller guard, full length

Multi-shank ripper (for D61EX/PX)

Weight..... 1757 kg **3,874 lb**
 Beam length..... 2170 mm **7'1"**
 Maximum lift above ground..... 560 mm **1'10"**
 Maximum digging depth..... 665 mm **2'2"**



ALLIED MANUFACTURER'S ATTACHMENTS (SHIPPED LOOSE)

- Guarding - Komatsu (Ken Garner)
 - Front sweeps 298 kg **657 lb**
 - Hinged cab side screens 44 kg **97 lb**
 - Hinged cab rear screen 43 kg **95 lb**
 - Rear fan guard (HD) 12 kg **27 lb**
 - Polycarbonate front door inserts 41 kg **90 lb**
- Hydraulic winch - Allied H6H
 1325 kg **2,900 lb**