

CDS

# Self Priming Centrifugal Pump

**Super  
T SERIES****Model T10A61S-B****Size 10" x 10"****PUMP SPECIFICATIONS****Size:** 10" x 10" (254 mm x 254 mm) Flanged.**Casing:** Gray Iron 30.

Maximum Operating Pressure 99 psi (683 kPa).\*

**Semi-Open Type, Two Vane Impeller:** Stainless Steel 316.

Handles 3" (76.2 mm) Diameter Spherical Solids.

**Impeller Shaft:** Stainless Steel 17-4 PH.**Replaceable Wear Plate:** Stainless Steel 316.**Seal Plate:** Stainless Steel 316.**Removable Clean-out Cover Plate:** Gray Iron 30;  
9 lbs. (4 kg).**Flap Valve:** Neoprene w/Steel Reinforcing.**Bearing Housing:** Gray Iron 30.**Radial and Thrust Bearings:** Open Double Row Ball.**Bearing and Seal Cavity Lubrication:** SAE 30 Non-Detergent Oil.**Suction Flange:** Gray Iron 30.**Suction Head:** Gray Iron 30.**Gaskets:** Buna-N, PTFE, Cork, and Rubber.**O-Rings:** Buna-N.**Internal Wetted Hardware:** Stainless Steel 316.**External Hardware:** Standard Plated Steel.**Pressure Relief Valve:** Stainless Steel 316.**Bearing and Seal Cavity Oil Level Sight Gauges.****Optional Equipment:** Metal Bellows Seal. Automatic Air

Release Valve. Stainless Steel CD4MCu Impeller, Seal Plate and Wear Plate. High Pump Temperature Shutdown Kit. 120V/240V Casing Heater.

Gray Iron 30 Spool Flanges:

10" ASA Discharge.

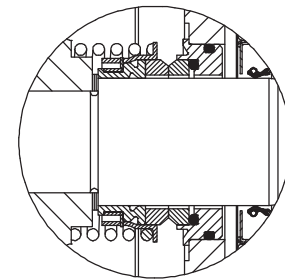
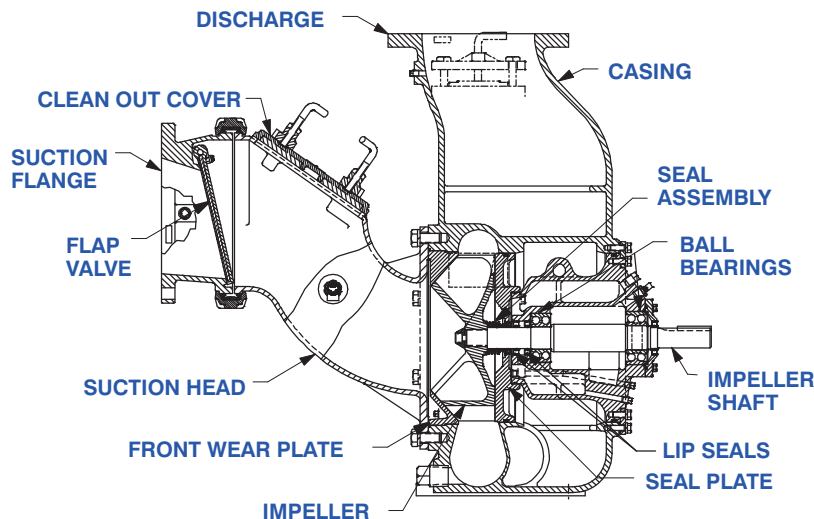
250 mm DIN 2527 (PN 16) Suction and Discharge  
(Specify Model T10A61S-B /FM).*\*Consult Factory for Applications Exceeding Maximum Pressure and/or Temperature Indicated.***Shown with Optional Discharge Spool Flange (Suction/Discharge Spool Flanges Available in ASA or DIN Standard Sizes).****SEAL DETAIL**

Mechanical, Oil-Lubricated, Double Floating, Self-Aligning. Silicon Carbide Rotating and Stationary Faces. Stainless Steel 316 Stationary Seat. Fluorocarbon Elastomers (DuPont Viton® or Equivalent). Stainless Steel 18-8 Cage and Spring. Maximum Temperature of Liquid Pumped, 160°F (71°C).\*

**THE GORMAN-RUPP COMPANY • MANSFIELD, OHIO**

GORMAN-RUPP OF CANADA LIMITED • ST. THOMAS, ONTARIO, CANADA

www.grpumps.com

Specifications Subject to Change Without Notice

Printed in U.S.A.

**Specification Data**

**NET WEIGHT:** 1455 LBS. (660 KG.)\*  
**SHIPPING WEIGHT:** 1605 LBS. (728 KG.)\*  
**EXPORT CRATE:** 70.3 CU. FT. (2 CU. M.)  
**\*ADD 71 LBS. (32,2 KG.) W/DISCH SPOOL FLANGE**

**SECTION 55, PAGE 2420**

**APPROXIMATE DIMENSIONS and WEIGHTS**

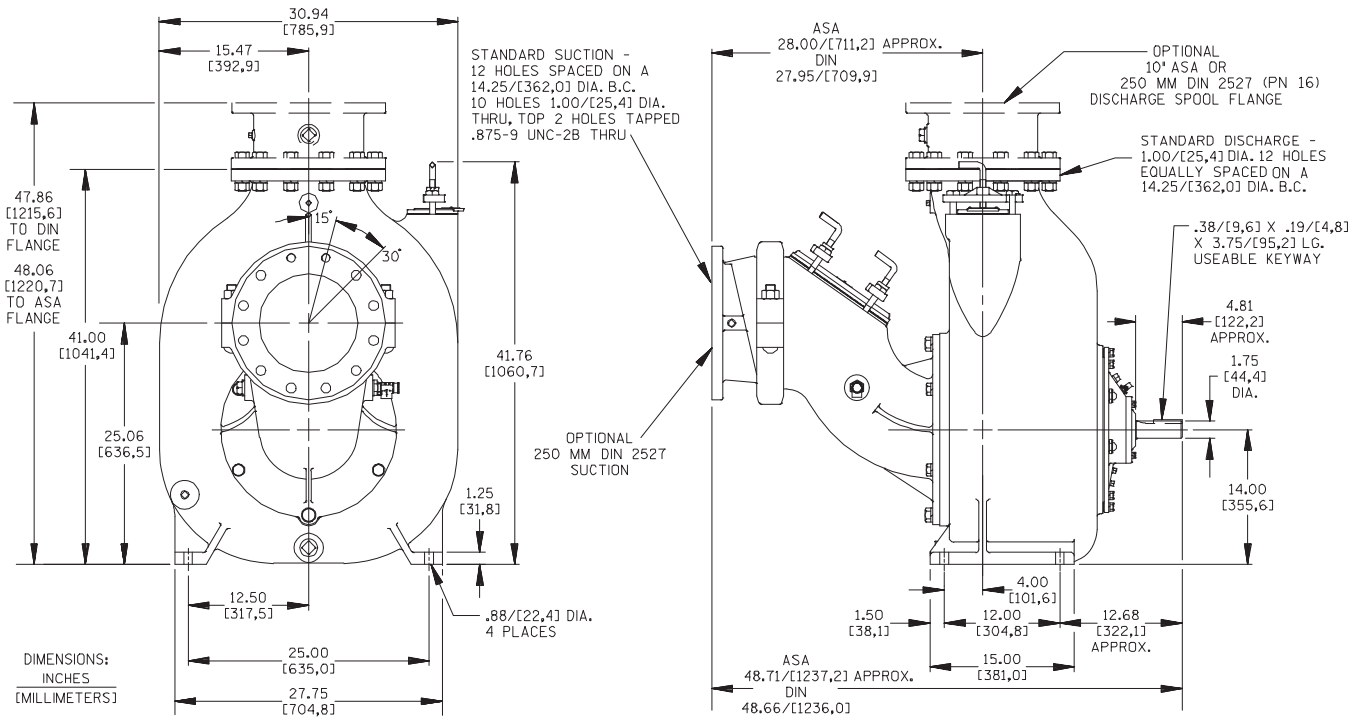

**OPTIONAL ASA OR DIN STANDARD SPOOL FLANGES AVAILABLE**

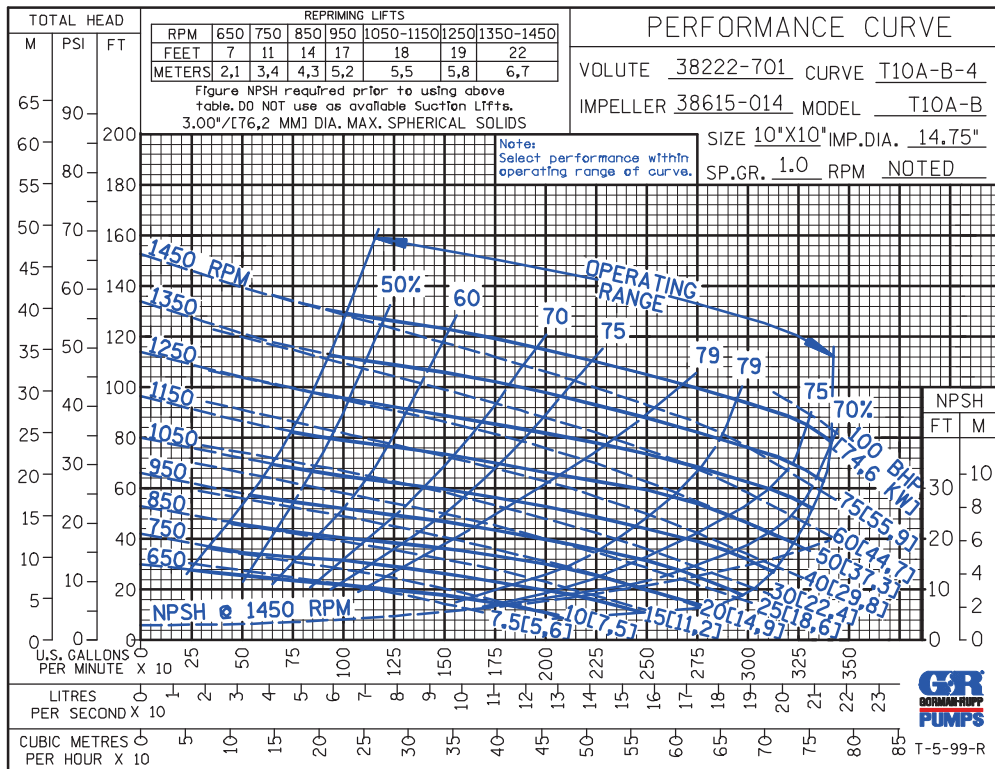

**THE GORMAN-RUPP COMPANY • MANSFIELD, OHIO**

GORMAN-RUPP OF CANADA LIMITED • ST. THOMAS, ONTARIO, CANADA

Specifications Subject to Change Without Notice

Printed in U.S.A.

CDS

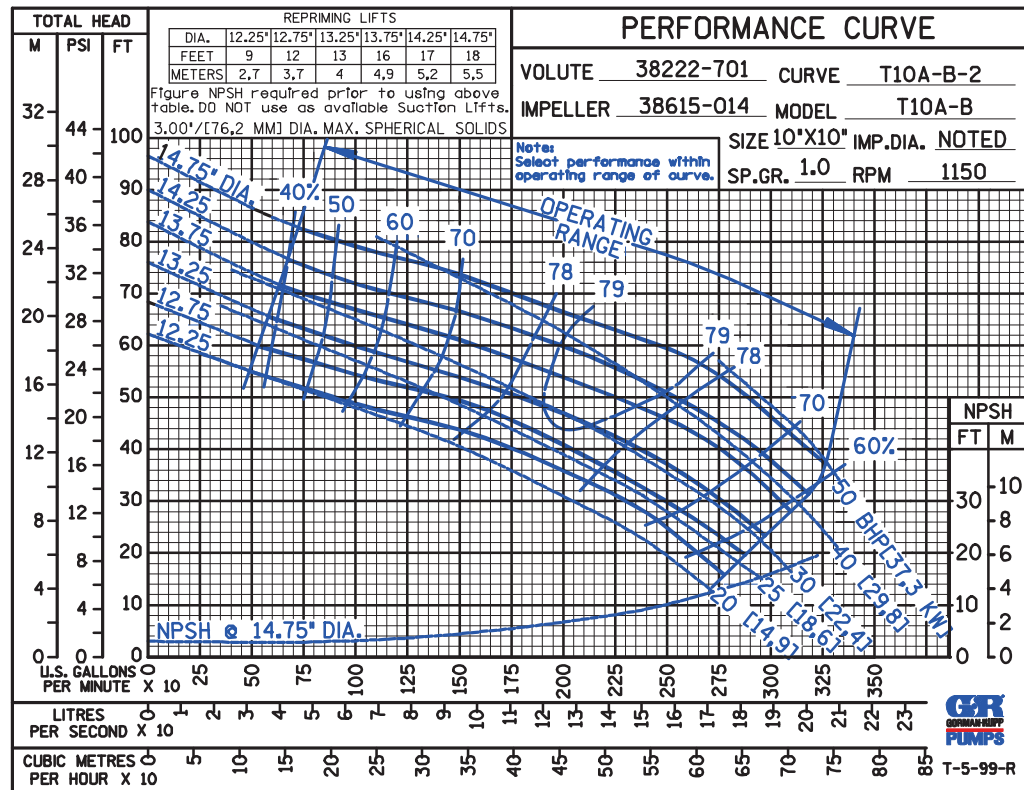
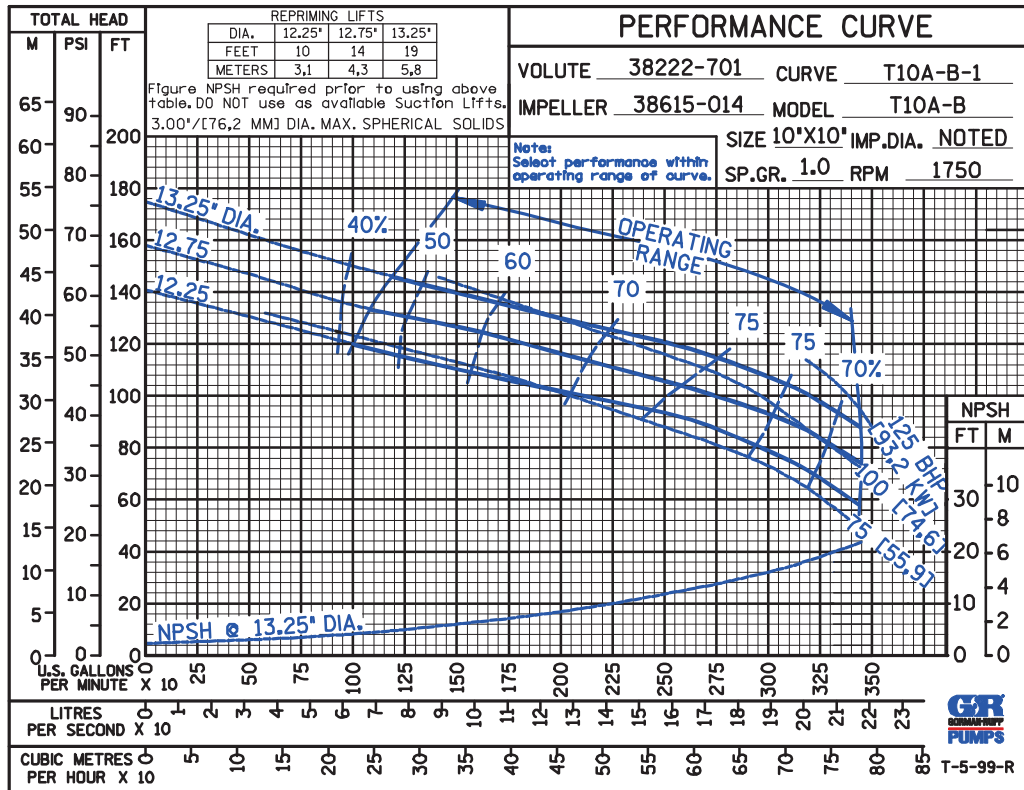

THE GORMAN-RUPP COMPANY • MANSFIELD, OHIO

GORMAN-RUPP OF CANADA LIMITED • ST. THOMAS, ONTARIO, CANADA

Specifications Subject to Change Without Notice

Printed in U.S.A.

CDS

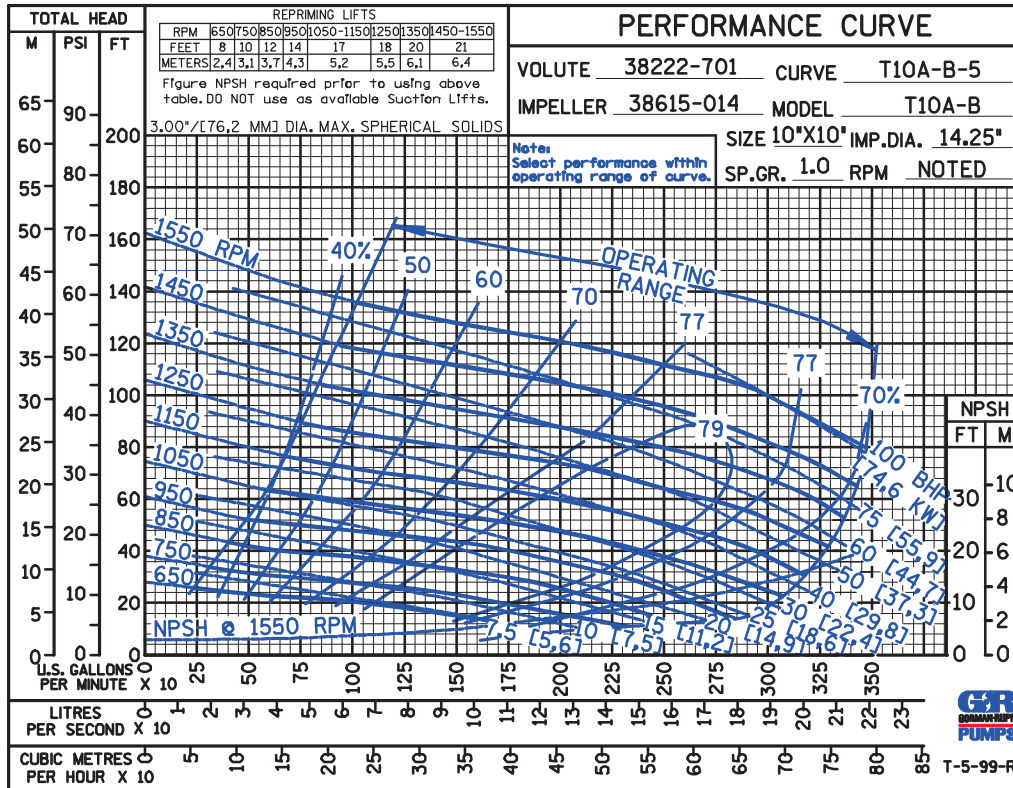
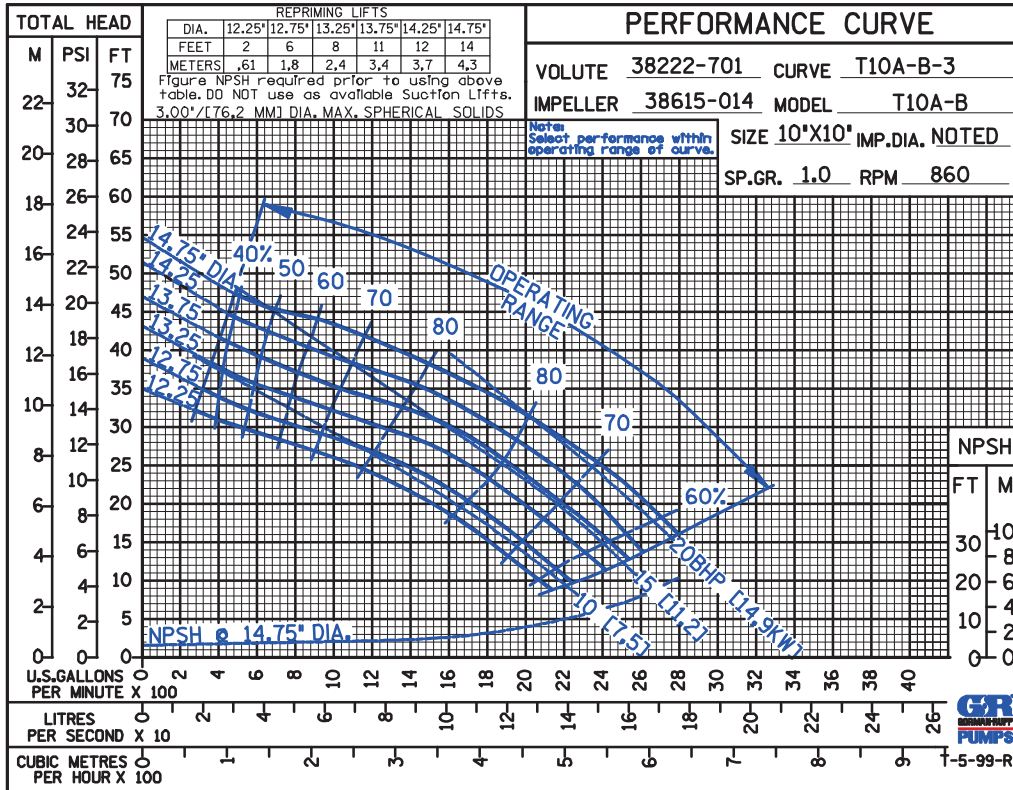

THE GORMAN-RUPP COMPANY • MANSFIELD, OHIO

GORMAN-RUPP OF CANADA LIMITED • ST. THOMAS, ONTARIO, CANADA

Specifications Subject to Change Without Notice

Printed in U.S.A.

CDS

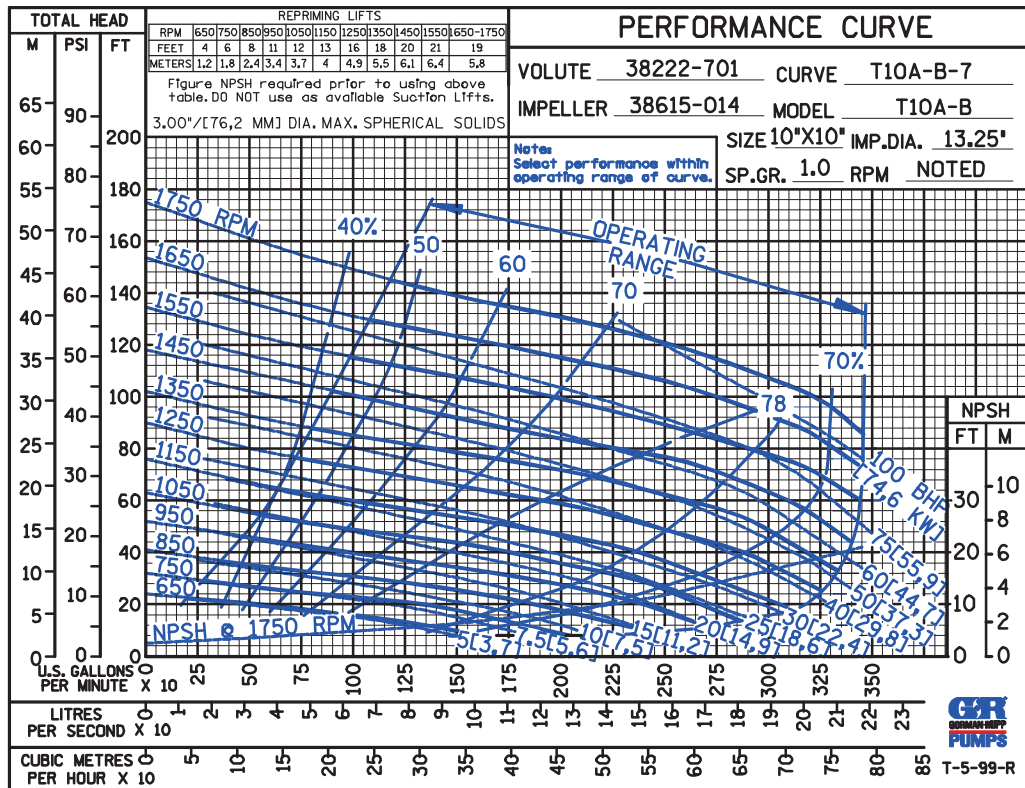
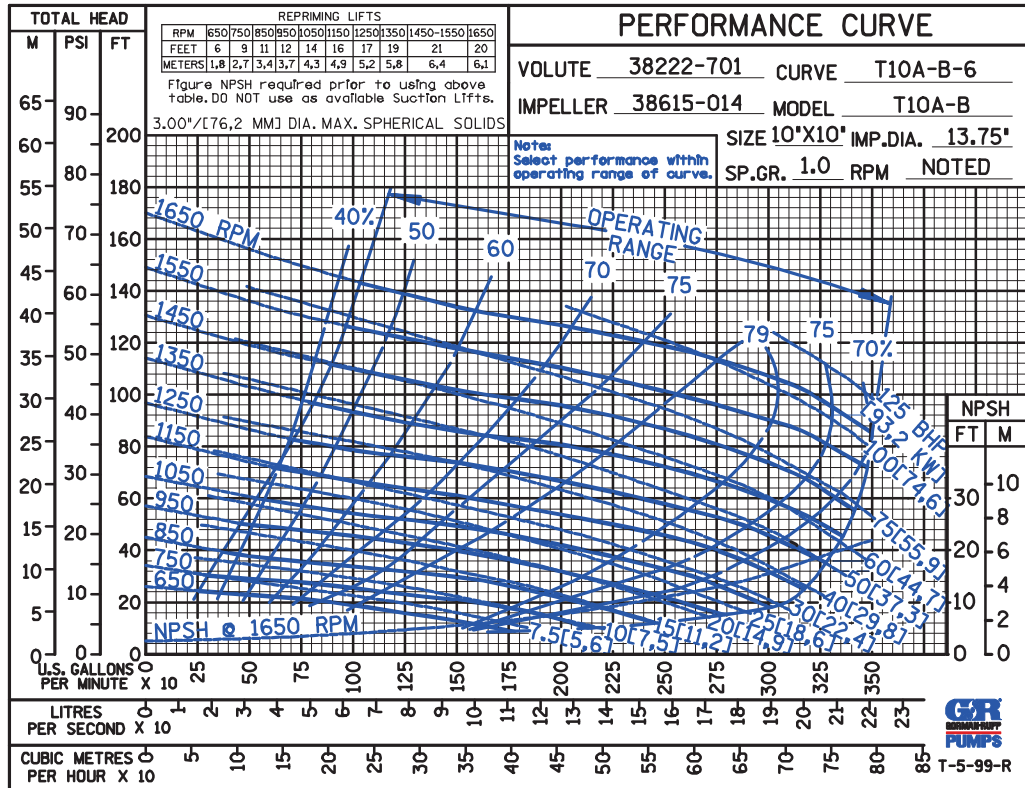

THE GORMAN-RUPP COMPANY • MANSFIELD, OHIO

GORMAN-RUPP OF CANADA LIMITED • ST. THOMAS, ONTARIO, CANADA

Specifications Subject to Change Without Notice

Printed in U.S.A.

CDS

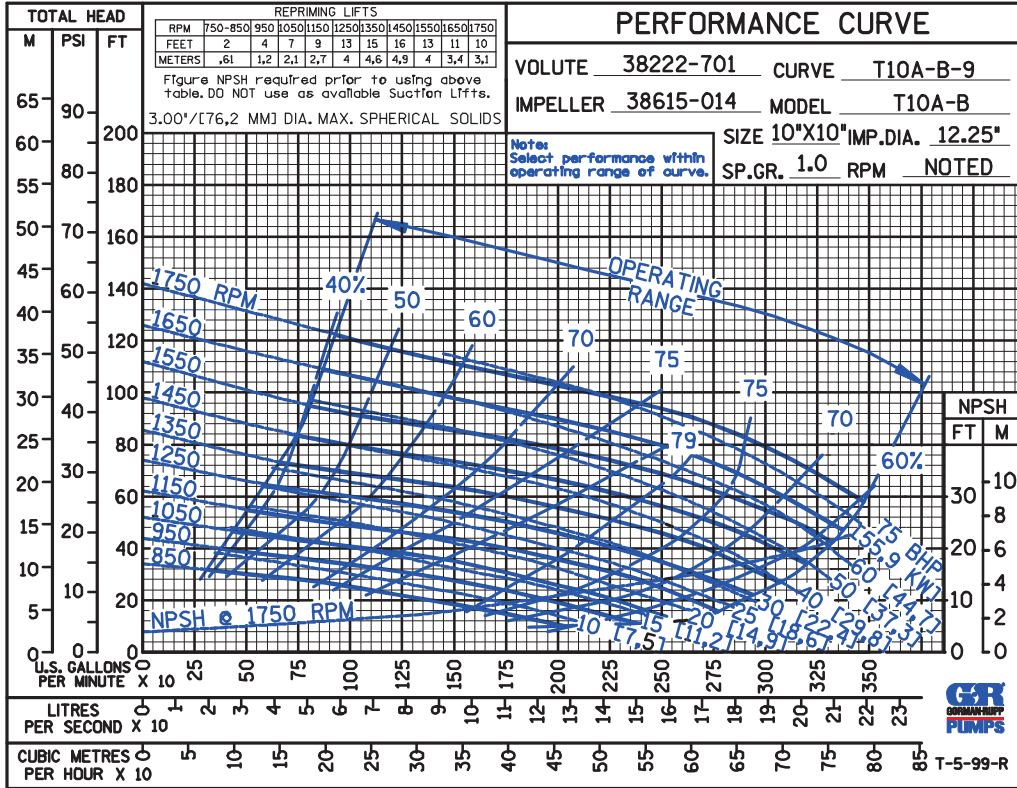
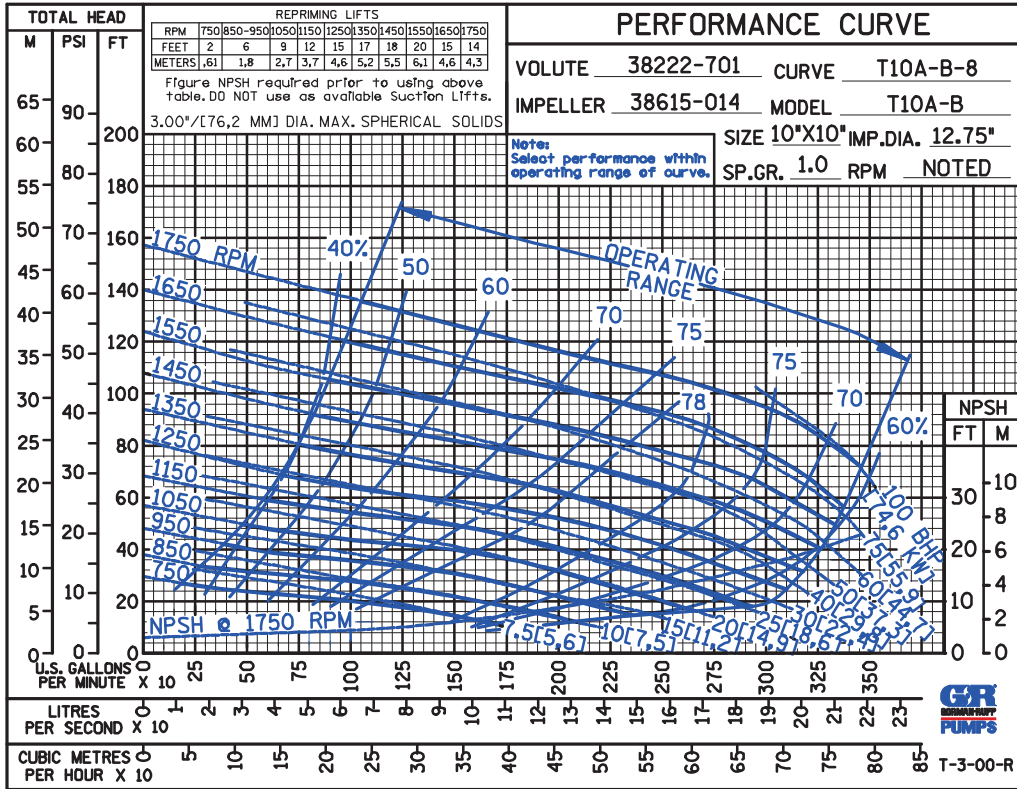

THE GORMAN-RUPP COMPANY • MANSFIELD, OHIO

GORMAN-RUPP OF CANADA LIMITED • ST. THOMAS, ONTARIO, CANADA

Specifications Subject to Change Without Notice

Printed in U.S.A.

CDS

50 HERTZ

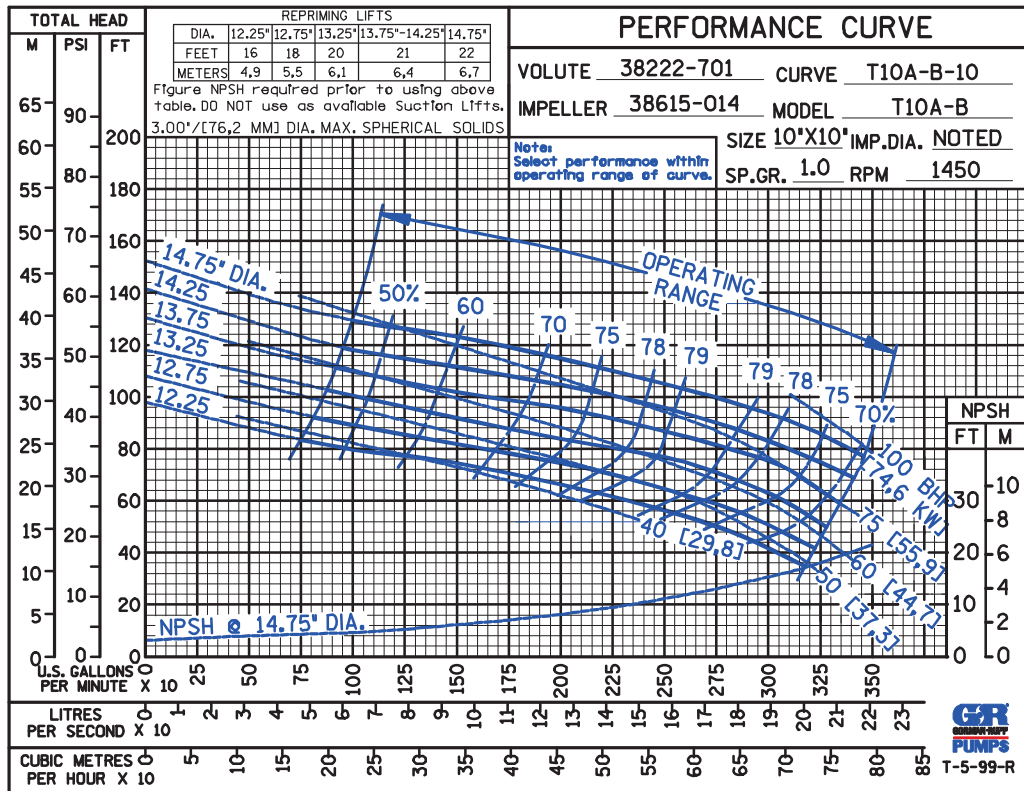

50 HERTZ

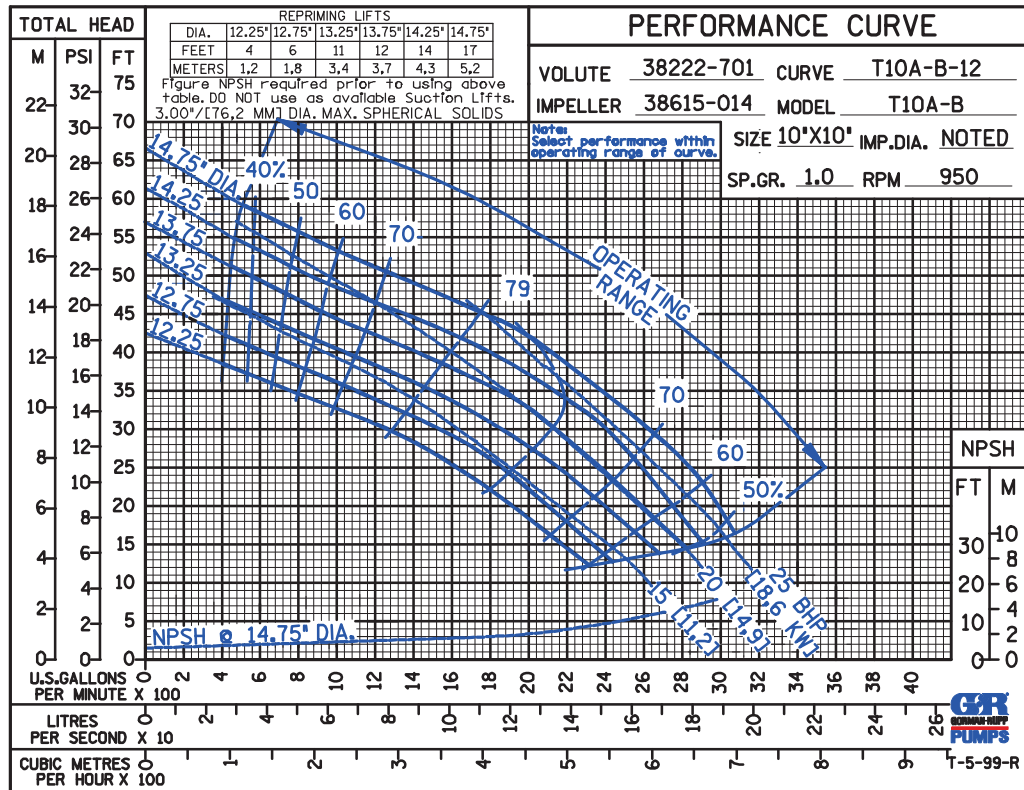

THE GORMAN-RUPP COMPANY • MANSFIELD, OHIO

GORMAN-RUPP OF CANADA LIMITED • ST. THOMAS, ONTARIO, CANADA

Specifications Subject to Change Without Notice

Printed in U.S.A.

D S

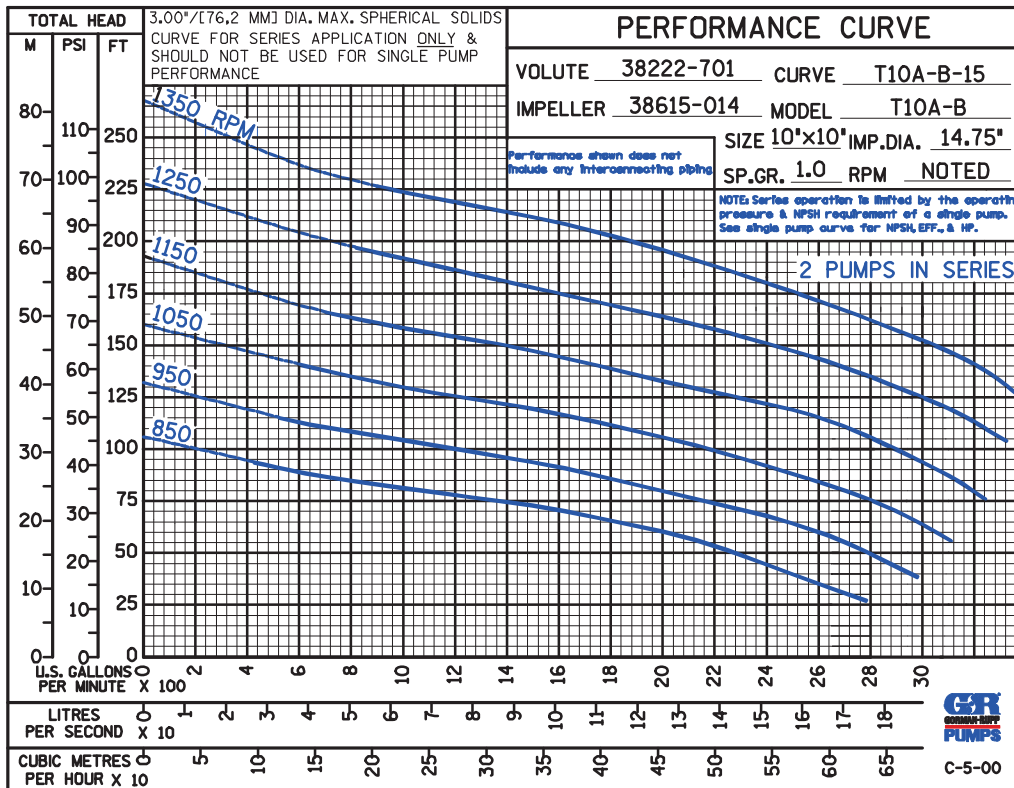
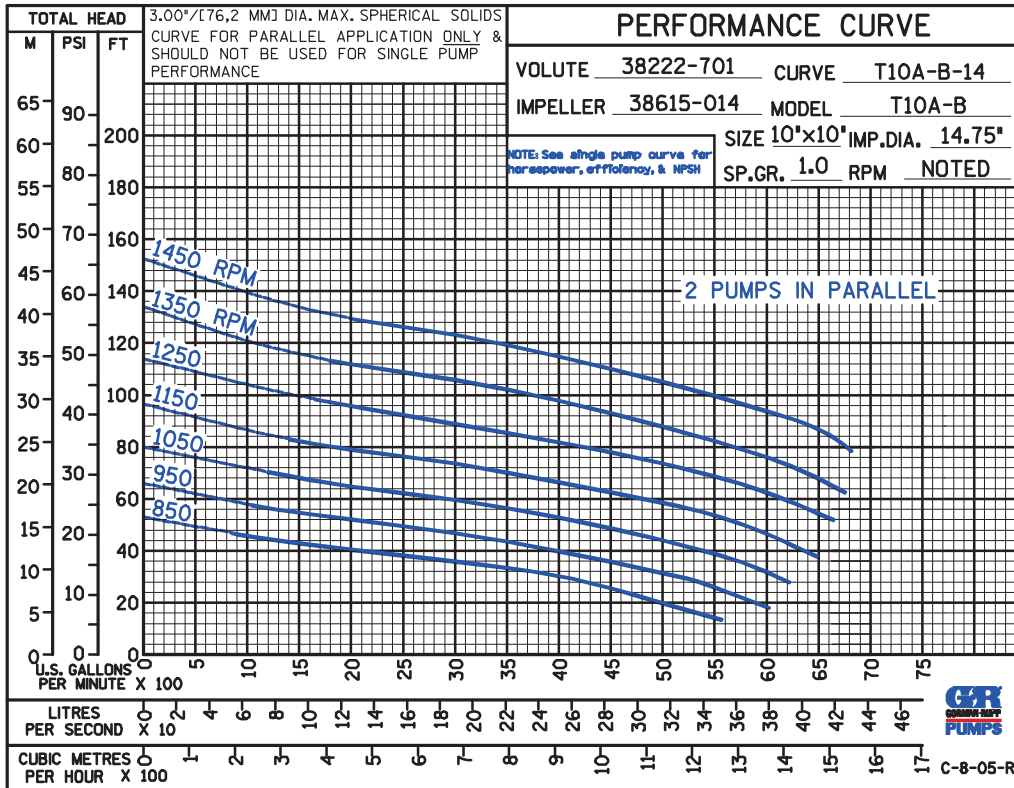

THE GORMAN-RUPP COMPANY • MANSFIELD, OHIO

GORMAN-RUPP OF CANADA LIMITED • ST. THOMAS, ONTARIO, CANADA

Specifications Subject to Change Without Notice

Printed in U.S.A.



CDS

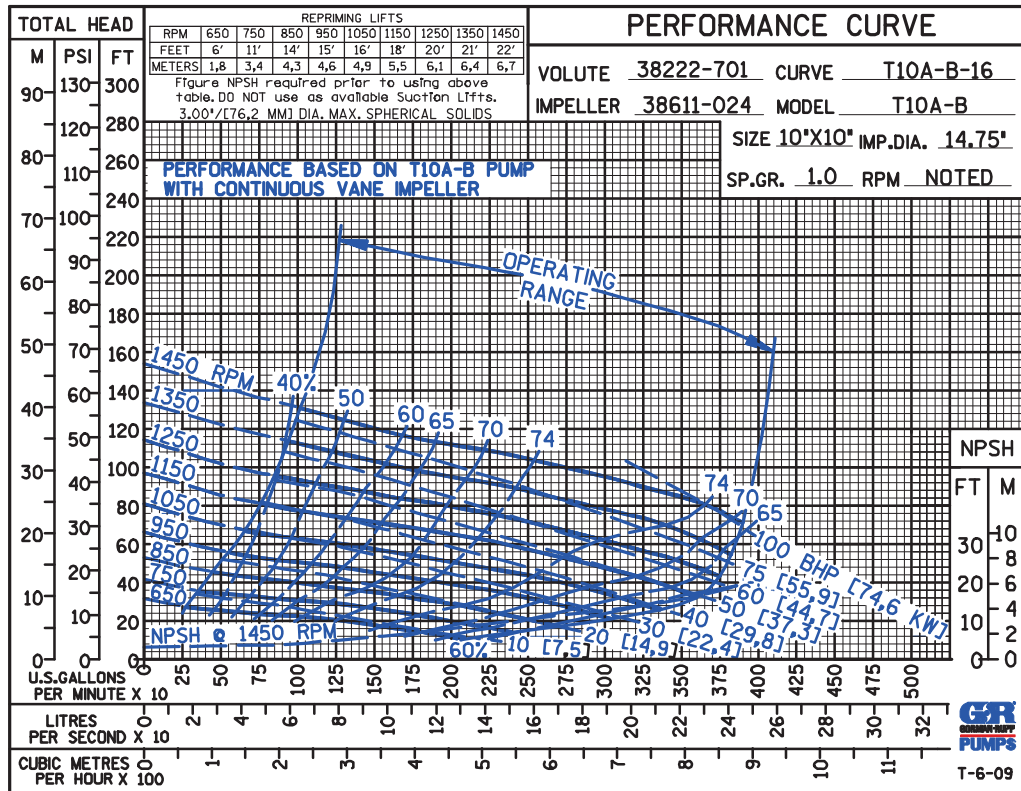

THE GORMAN-RUPP COMPANY • MANSFIELD, OHIO

GORMAN-RUPP OF CANADA LIMITED • ST. THOMAS, ONTARIO, CANADA

Specifications Subject to Change Without Notice

Printed in U.S.A.