

CDS

Self Priming Centrifugal Pump

**Super
T SERIES****Model T10A65S-B
Size 10" x 10"****PUMP SPECIFICATIONS****Size:** 10" x 10" (254 mm x 254 mm) Flanged.**Casing:** Stainless Steel CD4MCu.

Maximum Operating Pressure 99 psi (683 kPa).*

Semi-Open Type, Two Vane Impeller: Stainless Steel CD4MCu.

Handles 3" (76,2 mm) Diameter Spherical Solids.

Impeller Shaft: Stainless Steel 17-4 PH.**Replaceable Wear Plate:** Stainless Steel CD4MCu.**Seal Plate:** Stainless Steel CD4MCu.**Removable Clean-out Cover Plate:** Stainless Steel CD4MCu;
9 lbs. (4 kg).**Flap Valve:** Fluorocarbon (DuPont Viton® or Equivalent)
w/Stainless Steel Reinforcing.**Bearing Housing:** Stainless Steel CD4MCu.**Seal Plate:** Stainless Steel CD4MCu.**Radial and Thrust Bearings:** Open Double Row Ball.**Bearing and Seal Cavity Lubrication:** SAE 30 Non-Detergent Oil.**Suction Flange:** Stainless Steel CD4MCu.**Suction Head:** Stainless Steel CD4MCu.**Gaskets:** Fluorocarbon (DuPont Viton® or Equivalent), and PTFE.**O-Rings:** Fluorocarbon (DuPont Viton® or Equivalent).**Hardware:** Stainless Steel 316.**Pressure Relief Valve:** Stainless Steel 316.**Bearing and Seal Cavity Oil Level Sight Gauges.****Optional Equipment:** Metal Bellows Seal. Automatic Air

Release Valve. High Pump Temperature Shutdown

Kit. 120V/240V Casing Heater.

Stainless Steel CD4MCu Spool Flanges:

10" ASA Discharge.

250 mm DIN 2527 (PN 16) Suction and Discharge.

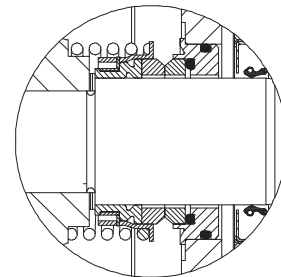
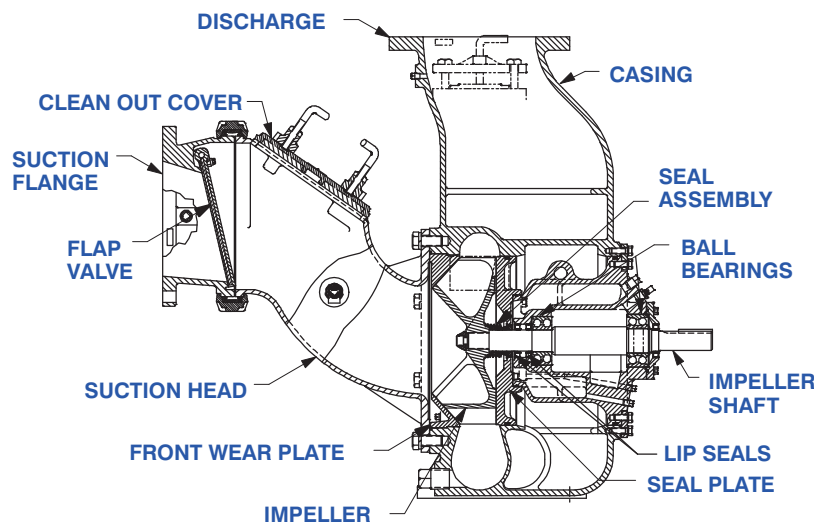
**Consult Factory for Applications Exceeding Maximum
Pressure and/or Temperature Indicated.***Shown with Optional Discharge Spool
Flange (Suction/Discharge Spool Flanges
Available in ASA or DIN Standard Sizes).****SEAL DETAIL**

Mechanical, Oil-Lubricated, Double Floating, Self-Aligning. Silicon Carbide Rotating and Stationary Faces. Stainless Steel 316 Stationary Seat. Fluorocarbon Elastomers (DuPont Viton® or Equivalent). Stainless Steel 18-8 Cage and Spring. Maximum Temperature of Liquid Pumped, 160°F (71°C).*

**THE GORMAN-RUPP COMPANY • MANSFIELD, OHIO**

GORMAN-RUPP OF CANADA LIMITED • ST. THOMAS, ONTARIO, CANADA

www.grpumps.com

Specifications Subject to Change Without Notice

Printed in U.S.A.

Specification Data

SECTION 55, PAGE 2430

APPROXIMATE DIMENSIONS and WEIGHTS

NET WEIGHT: 1504 LBS. (682 KG.)*
SHIPPING WEIGHT: 1562 LBS. (708 KG.)*
EXPORT CRATE: 53.0 CU. FT. (1,5 CU. M.)
***ADD 79 LBS. (35,8 KG.) W/DISCH SPOOL FLANGE**

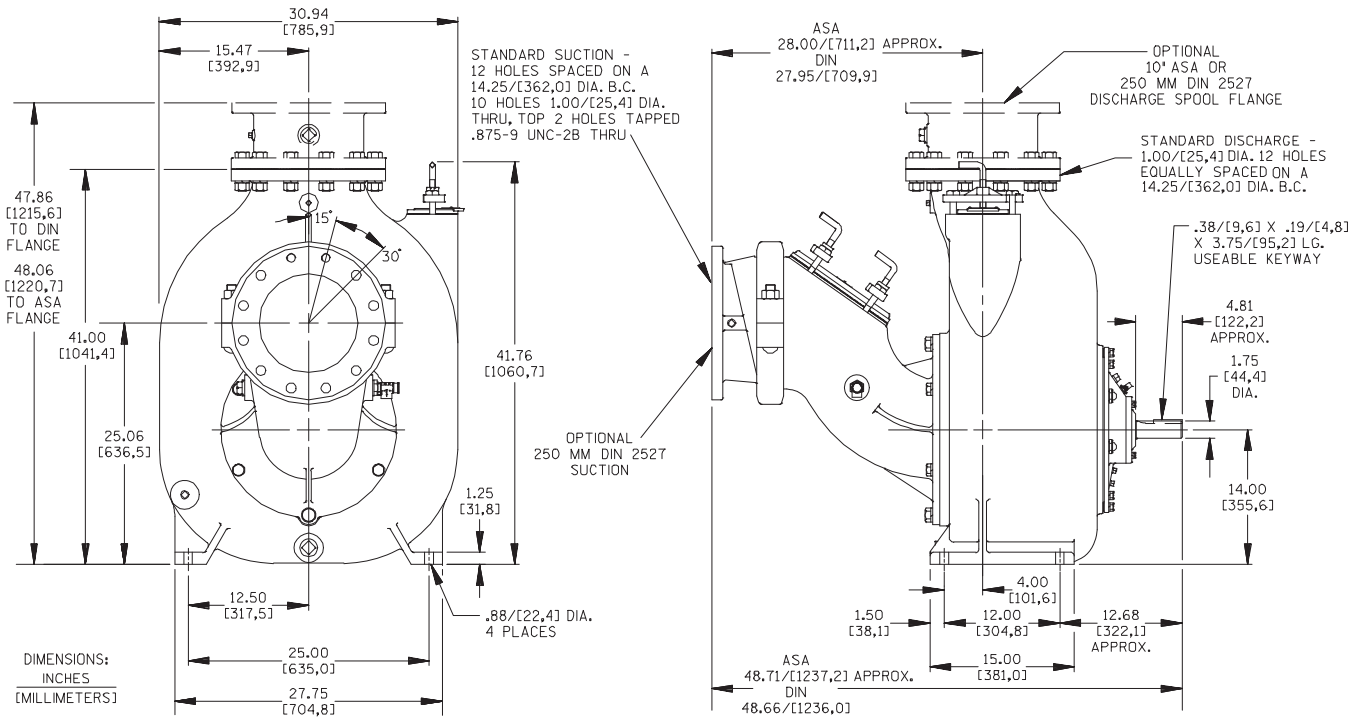

OPTIONAL ASA OR DIN STANDARD SPOOL FLANGES AVAILABLE

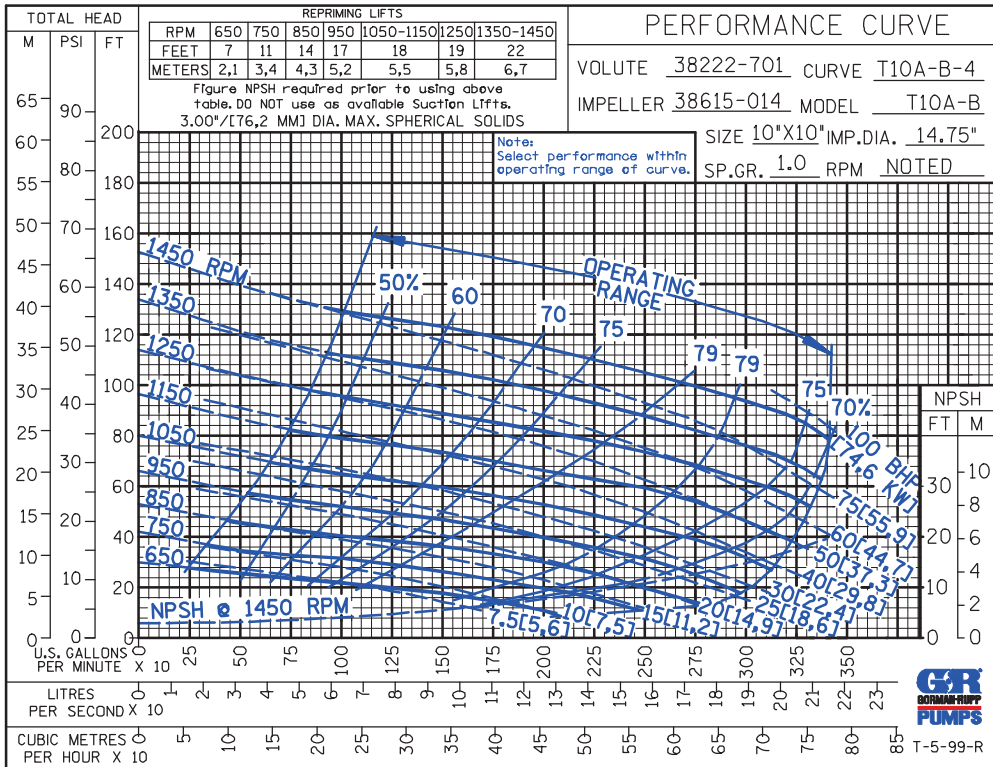

THE GORMAN-RUPP COMPANY • MANSFIELD, OHIO

GORMAN-RUPP OF CANADA LIMITED • ST. THOMAS, ONTARIO, CANADA

Specifications Subject to Change Without Notice

Printed in U.S.A.

CDS

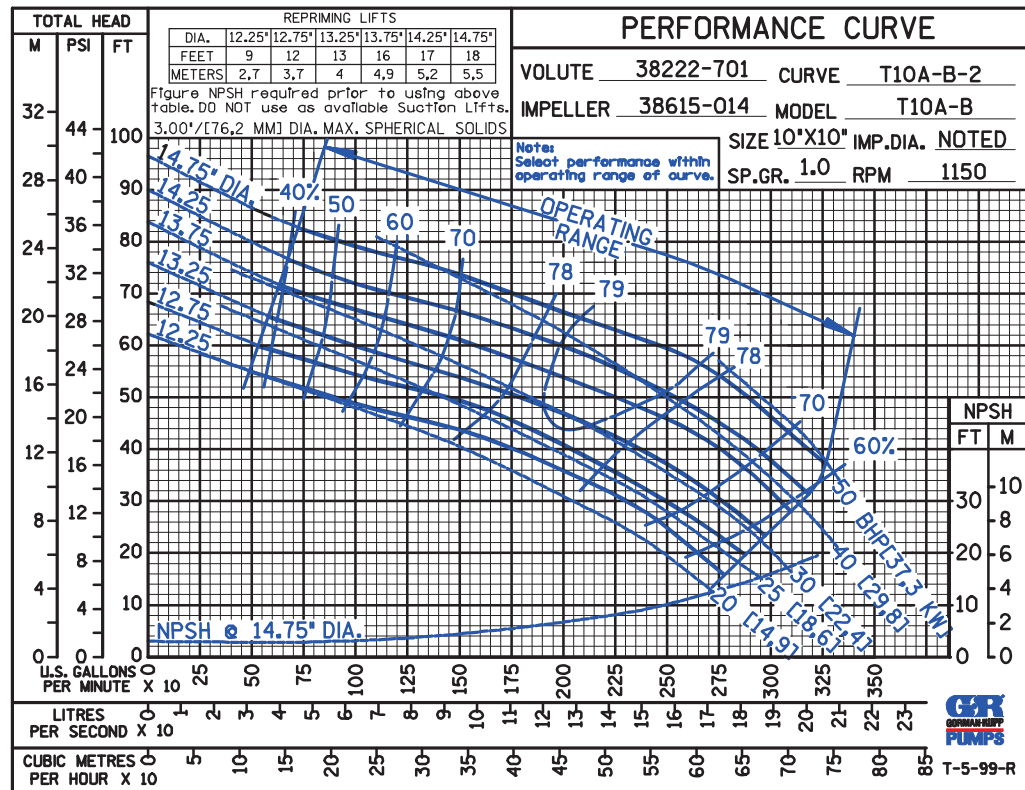
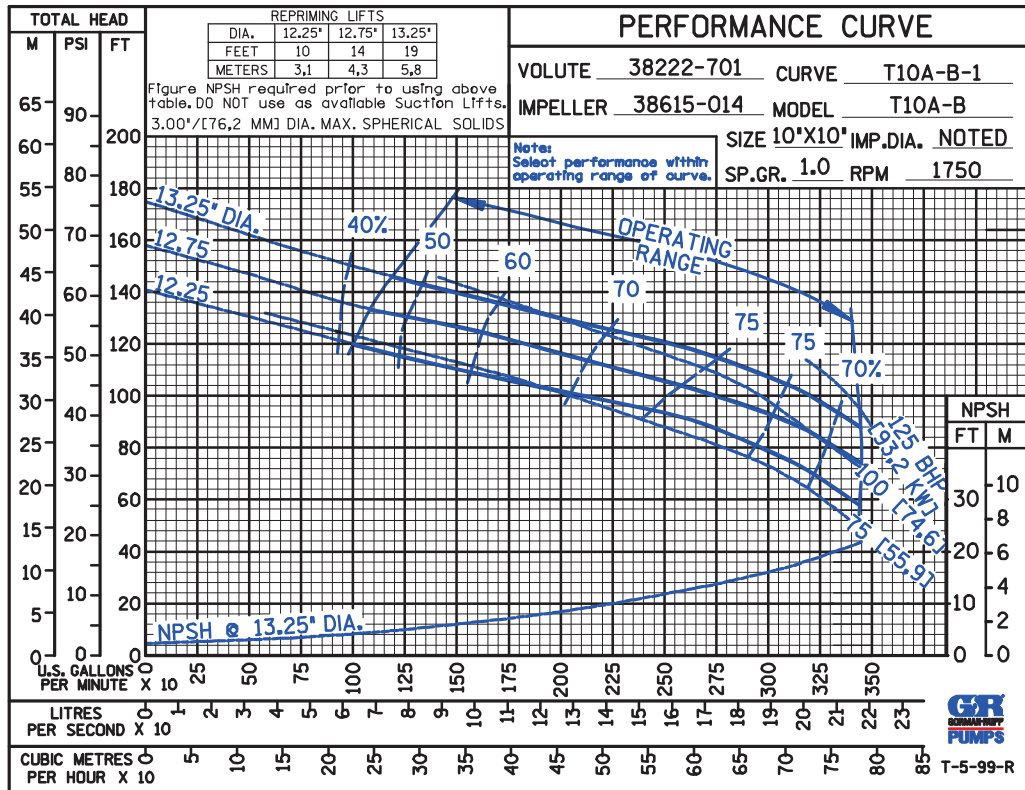

THE GORMAN-RUPP COMPANY • MANSFIELD, OHIO

GORMAN-RUPP OF CANADA LIMITED • ST. THOMAS, ONTARIO, CANADA

Specifications Subject to Change Without Notice

Printed in U.S.A.

CDS

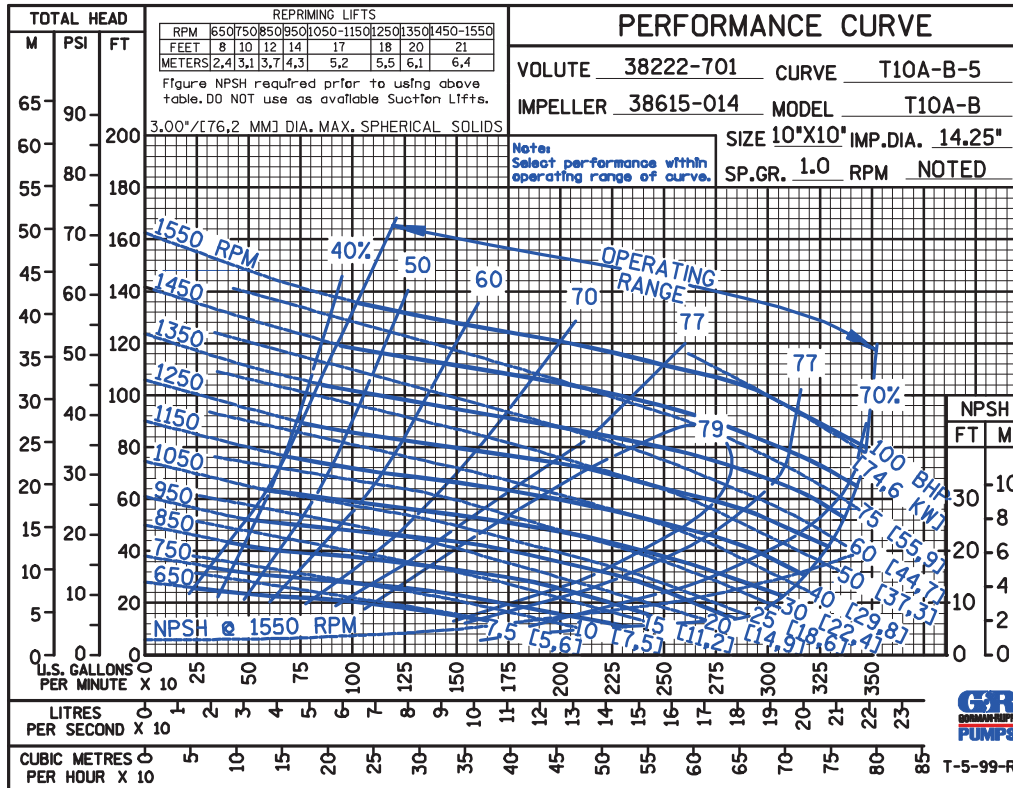
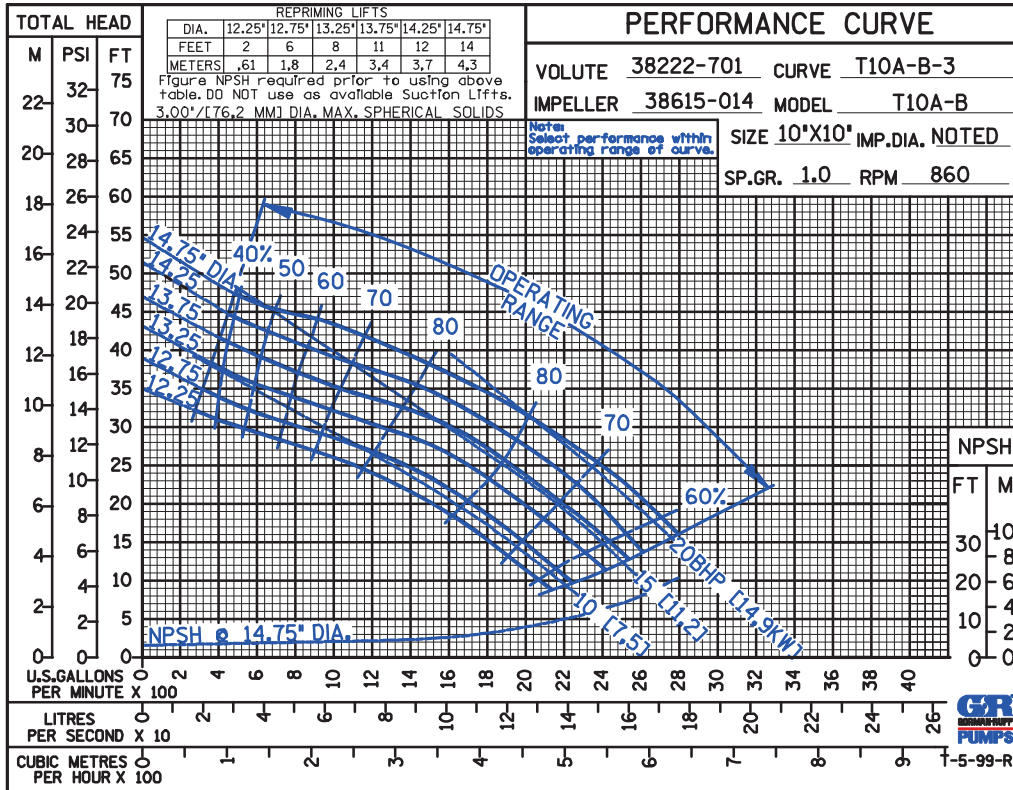

THE GORMAN-RUPP COMPANY • MANSFIELD, OHIO

GORMAN-RUPP OF CANADA LIMITED • ST. THOMAS, ONTARIO, CANADA

Specifications Subject to Change Without Notice

Printed in U.S.A.

CDS

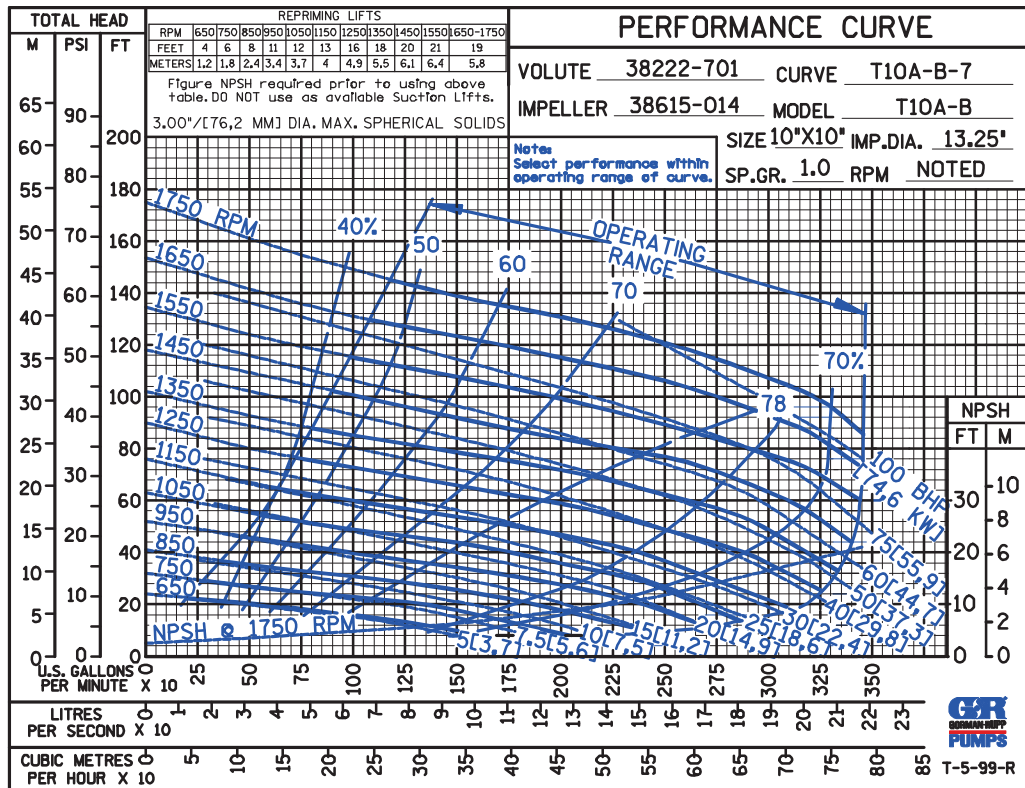
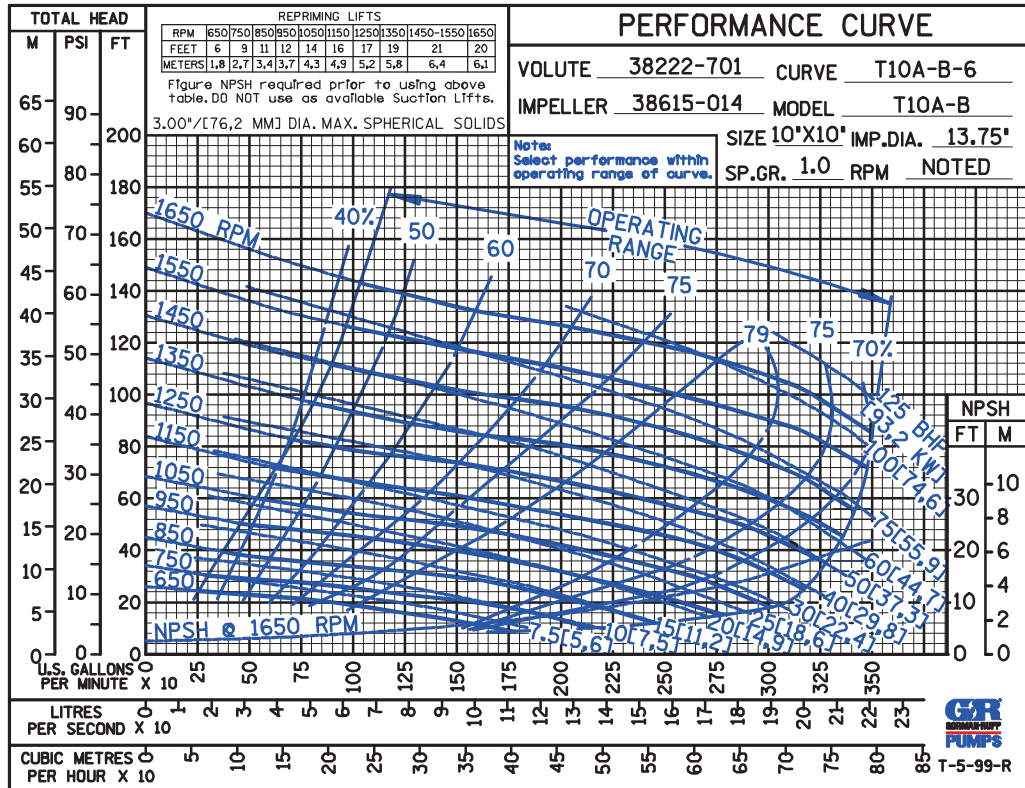

THE GORMAN-RUPP COMPANY • MANSFIELD, OHIO

GORMAN-RUPP OF CANADA LIMITED • ST. THOMAS, ONTARIO, CANADA

Specifications Subject to Change Without Notice

Printed in U.S.A.

CDS

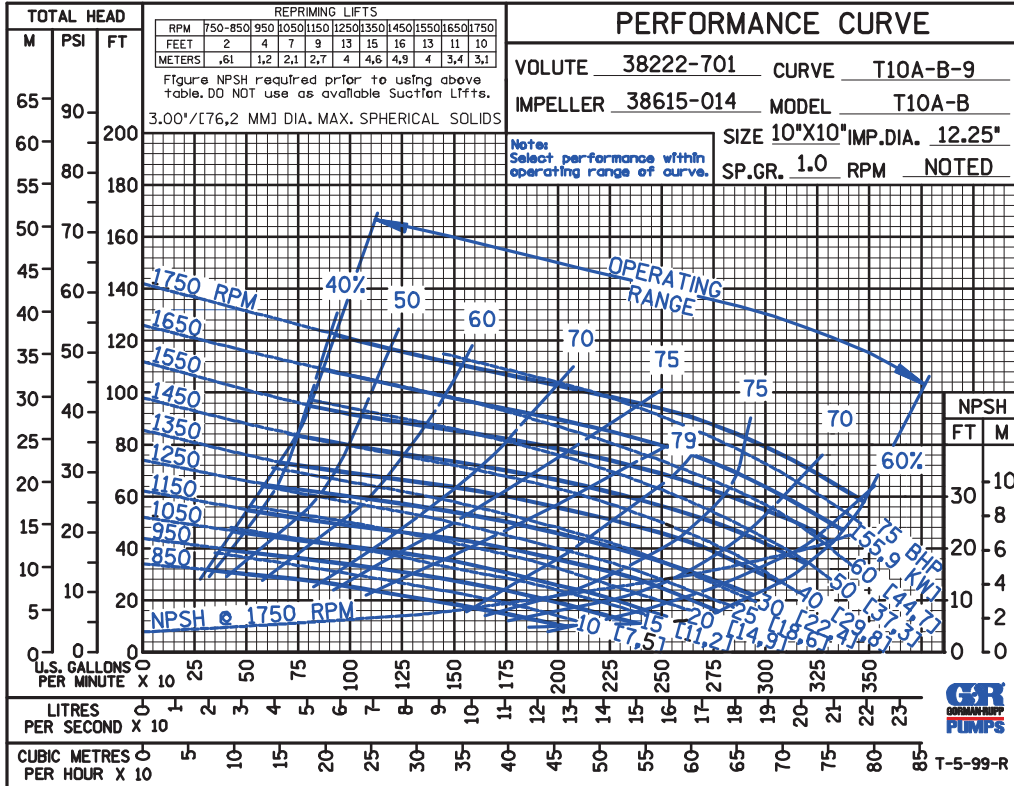
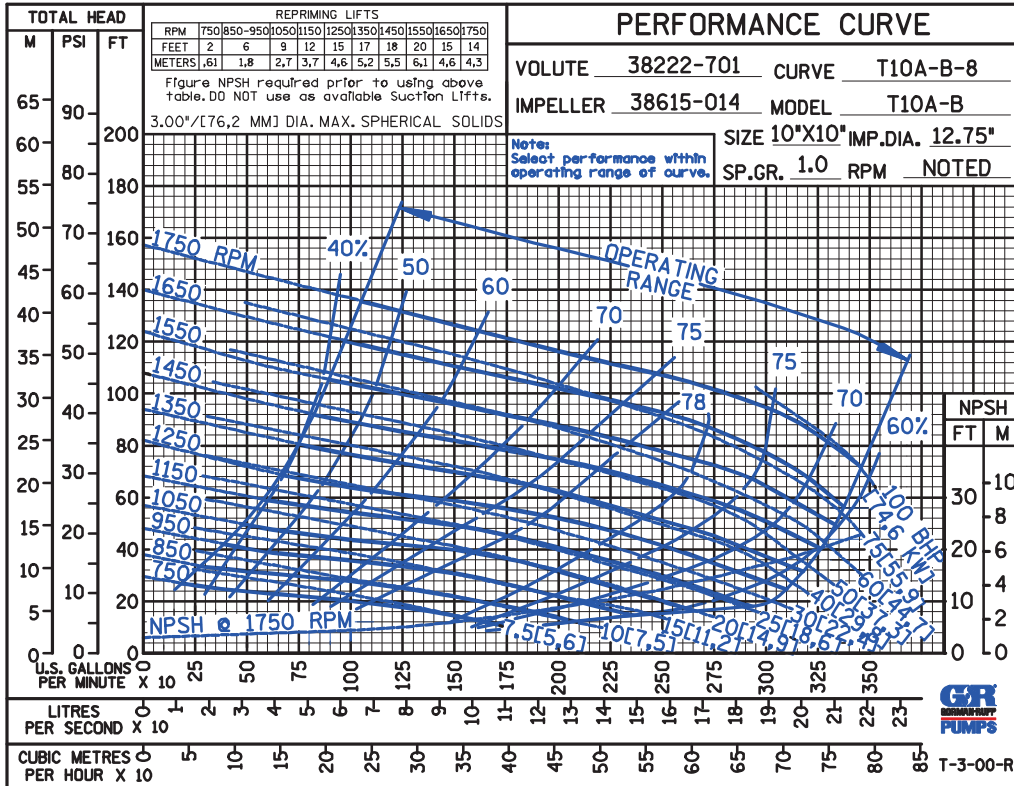

THE GORMAN-RUPP COMPANY • MANSFIELD, OHIO

GORMAN-RUPP OF CANADA LIMITED • ST. THOMAS, ONTARIO, CANADA

Specifications Subject to Change Without Notice

Printed in U.S.A.

CDS

50 HERTZ

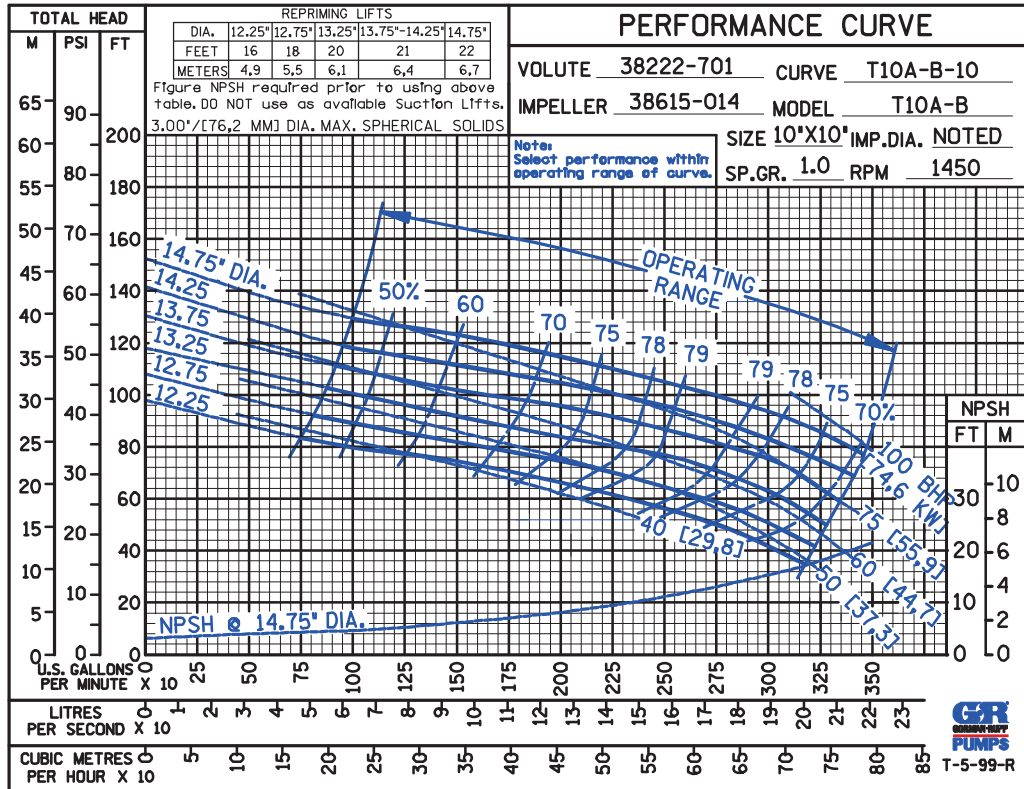

50 HERTZ

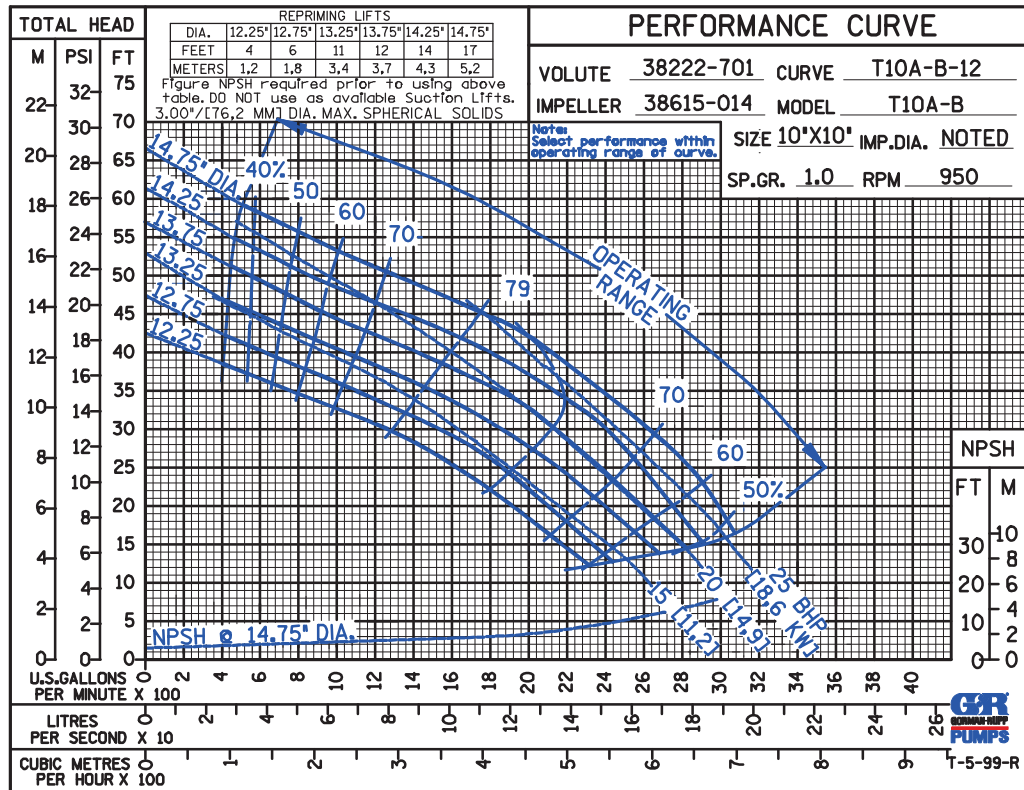

THE GORMAN-RUPP COMPANY • MANSFIELD, OHIO

GORMAN-RUPP OF CANADA LIMITED • ST. THOMAS, ONTARIO, CANADA

Specifications Subject to Change Without Notice

Printed in U.S.A.

D S

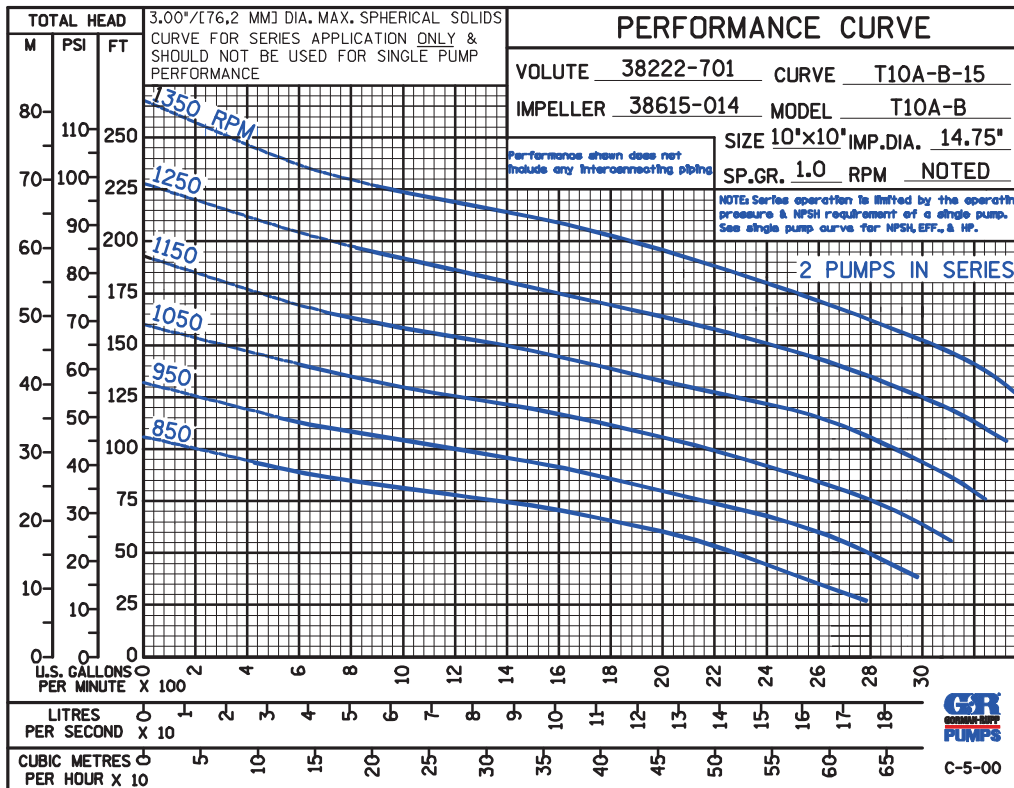
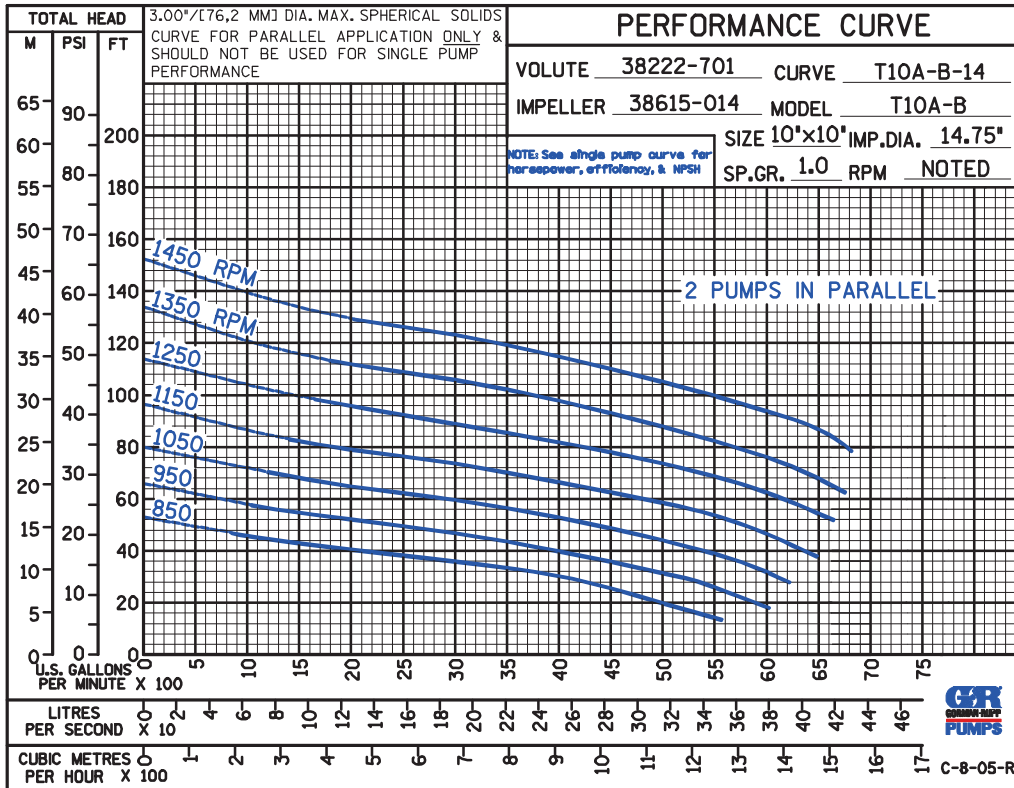

THE GORMAN-RUPP COMPANY • MANSFIELD, OHIO

GORMAN-RUPP OF CANADA LIMITED • ST. THOMAS, ONTARIO, CANADA

Specifications Subject to Change Without Notice

Printed in U.S.A.

CDS

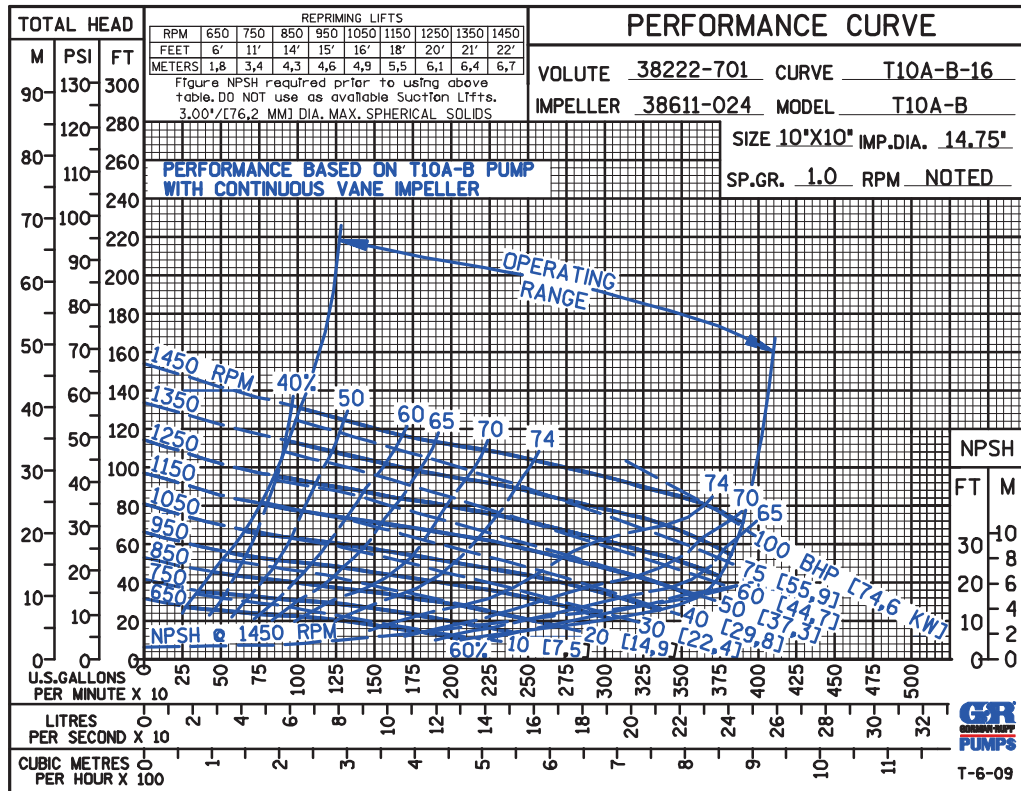

THE GORMAN-RUPP COMPANY • MANSFIELD, OHIO

GORMAN-RUPP OF CANADA LIMITED • ST. THOMAS, ONTARIO, CANADA

Specifications Subject to Change Without Notice

Printed in U.S.A.