

KOMATSU®

HM300-3 Tier 4 Interim Engine

HM300

GROSS HORSEPOWER
332 HP 248 kW

NET HORSEPOWER
324 HP 242 kW

MAXIMUM GVW
116,823 lb 52990 kg



PHOTOS MAY INCLUDE OPTIONAL EQUIPMENT

HM300

WALK-AROUND

HM300-3



Photos may include optional equipment

HM300-3

Tier 4 Interim Engine

GROSS HORSEPOWER

332 HP 248 kW
@ 2000 rpm

NET HORSEPOWER

324 HP 242 kW
@ 2000 rpm

MAXIMUM GVW

116,823 lb
52990 kg



INCREASED PRODUCTIVITY AND BODY CAPACITY

Komatsu Traction Control System (KTCS) Automatically engages the inter axle differential locks and the KTCS braking to provide optimal traction in soft ground conditions.

Increased body capacity yields a 28.0 metric ton **30.9 US ton** payload.

High performance and environment-friendly SAA6D125E-6 engine:

- EPA Tier 4 Interim and EU Stage 3B emissions certified.
- Engine power mode selection system realizes both greater productivity and improved fuel economy.

Komatsu Variable Geometry Turbocharger (KVGTT) uses a hydraulic actuator to provide optimum air flow under all speed and load conditions.

Komatsu Diesel Particulate Filter (KDPF) captures 90% of particulate matter and provides automatic regeneration that does not interfere with daily operation.

Advanced diagnostic system continuously monitors machine operation and vital systems to identify machine issues and assist with troubleshooting.

Large LCD color monitor panel:

- 7" high resolution screen
- Provides "Eco-Guidance" for fuel efficient operation

Wide, spacious cab with excellent visibility:

- Center-located operator's seat
- Short nose design
- The rounded engine hood provides improved front visibility
- Color rearview monitoring system
- The wide cab offers a comfortable operator and passenger environment

For operator comfort:

- Low noise cab through improved sealing with integrated floor. Interior noise level 73 dB(A)
- Air suspension seat
- Radio with AUX terminal



Komatsu designed, electronically controlled transmission for a comfortable ride.

F6-R2 counter-shaft type transmission with K-ATOMiCS (Komatsu Advanced Transmission with Optimum Modulation Control System).

High capacity, reliable, continuously cooled, wet type multiple-disc brakes and retarder:

- Fully hydraulic controlled wet multiple-disc brakes
- Retarder absorbing capacity (continuous descent) 392 kW **526 HP**

Hydro-pneumatic suspension for all terrains.

The hydro-pneumatic suspension on both front and rear suspensions assures a comfortable ride even over rough terrain.

Easy-to-load body:

- Heaped capacity 17.1 m³ **22.4 yd³**
- Low loading height 2830 mm **9'3"**
- High strength body constructed of thick wear-resistant steel having 400 Brinell hardness



KOMTRAX®

Komtrax equipped machines can send location, SMR and operation maps to a secure website utilizing wireless technology. Machines also relay error codes, cautions, maintenance items, fuel levels, and much more.

Environment Friendly Engine

The Komatsu SAA6D125E-6 engine is EPA Tier 4 Interim and EU Stage 3B emissions certified and provides exceptional performance while reducing fuel consumption. Based on Komatsu proprietary technologies developed over many years, this new diesel engine reduces exhaust gas particulate matter (PM) by more than 90% and nitrogen oxides (NOx) by more than 45% when compared to Tier 3 levels.

Through the in-house development and production of engines, electronics and hydraulic components, Komatsu has achieved great advancements in technology, providing high levels of performance and efficiency in virtually all applications.

Advanced Electronic Control System

The engine control system has been upgraded to effectively manage a variety of parameters such as the air flow rate, EGR gas flow rate, fuel injection parameters and after treatment functions. The new control system also provides enhanced diagnostic capabilities.

Low noise

New hydraulically driven fans and redesigned layout of the cooling system helps achieve a low noise level that meets the EU regulation.

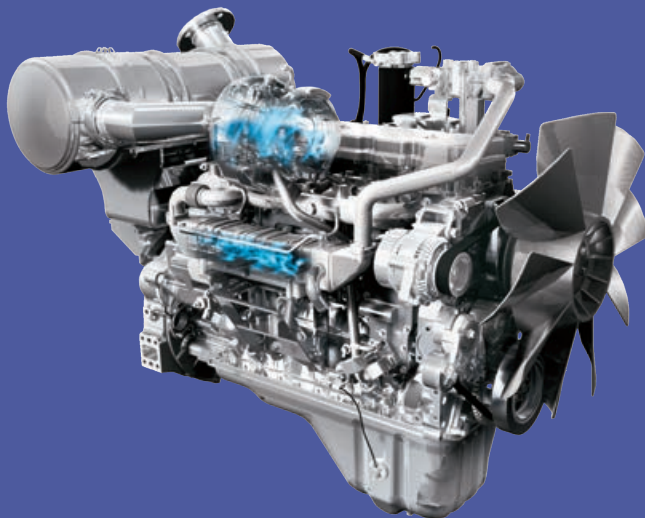

Komatsu Diesel Particulate Filter (KDPF)

Komatsu has developed a high efficiency diesel particulate filter that captures more than 90% of particulate matter. Both passive and active regeneration are automatically initiated by the engine controller depending on the soot level of the KDPF. A special oxidation catalyst with a fuel injection system is used to oxidize and remove particulate matter while the machine is running so the regeneration process will not interfere with daily operation. The operator can also initiate regeneration manually or disable regeneration depending on the work environment.

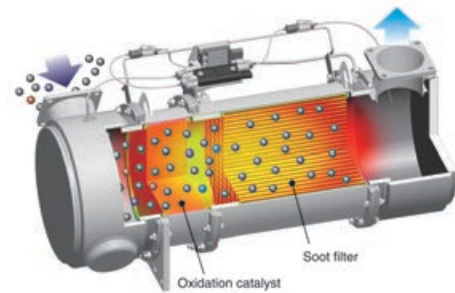

KDPF

Redesigned Combustion Chamber

The combustion chamber located at the top of the engine piston has a new shape designed to improve combustion and further reduce NOx, PM, fuel consumption, and noise levels.

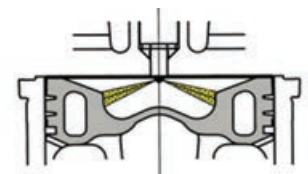

Komatsu Variable Geometry Turbocharger (KVTG)

Using Komatsu proprietary technology, a newly designed variable geometry turbocharger with a hydraulic actuator is used to manage and deliver optimum air flow to the combustion chamber under all speed and load conditions. The robust hydraulic actuator provides power and precision, resulting in cleaner exhaust gas and improved fuel economy while maintaining performance.

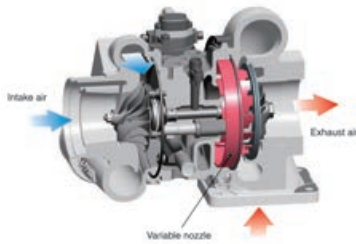

Cooled Exhaust Gas Recirculation (EGR)

Cooled EGR, a technology that has been well proven in Komatsu Tier 3 engines, reduces NOx emission to meet Tier 4 levels. The hydraulically-actuated EGR system has increased capacity and uses larger and more robust components to ensure reliability for demanding work conditions.

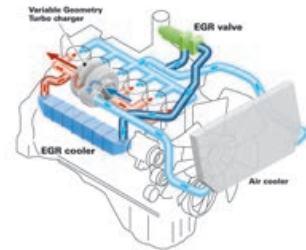

Heavy Duty High Pressure Common Rail (HPCR) Fuel Injection System

The heavy duty HPCR system is electronically controlled to deliver a precise quantity of pressurized fuel into the combustion chamber using multiple injection events to achieve complete fuel burn and reduce exhaust gas emissions. Fuel injector reliability has been improved by using ultra-hard wear resistant materials.

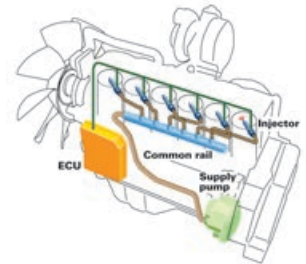

Closed Crankcase Ventilation (CCV)

Crankcase emissions (blow-by-gas) are passed through a CCV filter. The CCV filter traps oil mist which is returned back to the crankcase while the filtered gas is returned to the air intake.

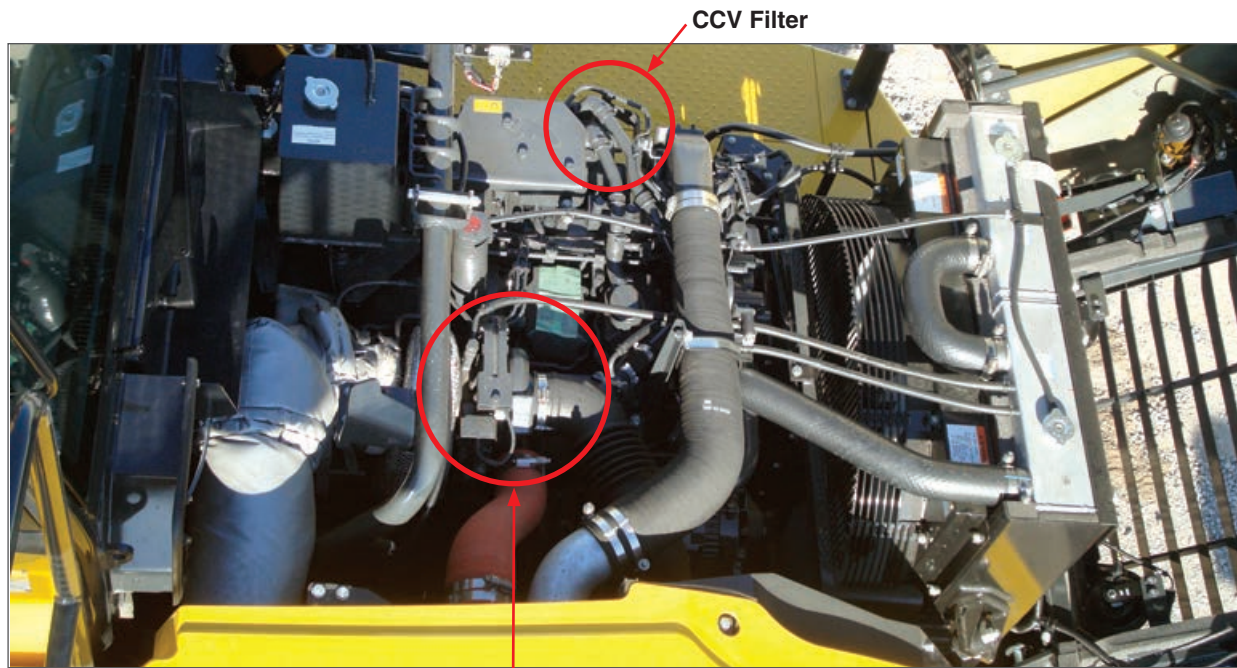

KVTG

Low fuel consumption

The fuel consumption for the HM300-3 has been lowered through energy saving improvements in the transmission, axles and advanced electronic engine control. All combined the HM300-3 realizes up to 8% better fuel economy in the field compared to the HM300-2.

Fuel consumption 8% reduction

*Compared with the HM300-2 fuel consumption. Varies depending on job conditions.

Komatsu Traction Control System (KTCS)

The new KTCS system was developed by Komatsu to allow for maximum machine performance in soft ground conditions. Komatsu leveraged its prior experience with traction control systems in bulldozers and rigid trucks to develop this system for use in articulated trucks.

The KTCS system monitors the wheel speed on the front and middle axles. If the machine detects wheel slip it will automatically engage the inter axle differential lock to improve machine performance. If the machine continues to detect wheel slip it will employ the KTCS and begin to brake the wheel that slip was detected on. It will continually monitor the wheel speed and engage braking as necessary.

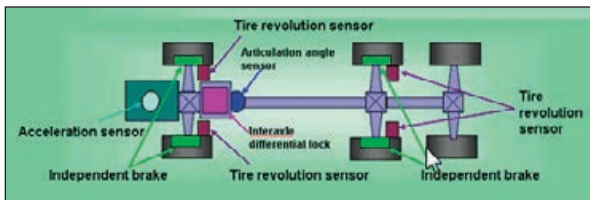

KTCS is automatically engaged and disengaged. This allows the operator to concentrate on operating the HM300-3 and not worry about using switches or buttons to get maximum machine performance.

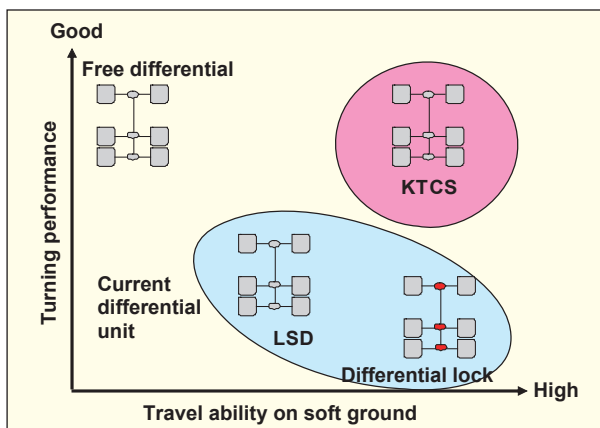

Selectable Working Modes

The operator can choose between two working modes, Economy Mode or Power Mode, according to their work demand and conditions.

Economy mode

Appropriate for lighter work on flat ground. The economy modes lowers the engine maximum output along with lowering the upshift and downshift points during operation.

Power mode

Appropriate for higher production jobs and uphill hauling applications. The power mode increases the engine maximum output and raises the upshift and downshift points during operation.



Komatsu designed electronically controlled countershaft transmission

The Komatsu designed electronically controlled transmission called K-ATOMiCS has been a success in Komatsu's rigid dump trucks. The electronic clutch modulation system ensures proper clutch pressure when the clutch is engaged. The total control system controls both the engine and transmission by monitoring the vehicle conditions. This high technology system assures smooth shifts without shock and maximizes power train life.

Increased body capacity and box section frame structure

The loading capacity is increased from 27.3 to 28.0 metric tons **30.1 to 30.9 U.S. tons** through increased body heaped capacity to 17.1 m³ **22.4 yd³**. The low loading height of 2830 mm **9'3"** enables easy loading. The body is built of high strength wear-resistant steel with a Brinell hardness of 400 and the body shapes provides excellent load stability.

MAINTENANCE FEATURES

KDPF Regeneration Notification

The LCD color monitor panel provides the operator with the status of the KDPF regeneration, without interfering with daily operation.

When the machine initiates active regeneration an icon will appear to notify the operator.



Manual Stationary Regeneration

Under most conditions, active regeneration will occur automatically with no effect on machine operation. In case the operator needs to disable active regeneration or initiate a manual stationary regeneration, this can be easily accomplished through the monitor panel.

A soot level indicator is displayed to show how much soot is trapped in the KDPF.



Multi-monitor with Troubleshooting Function to Help Prevent Critical Machine Trouble

Various meters, gauges and warning functions are centrally arranged on the multi-monitor. The monitor simplifies start-up inspection and promptly warns the operator with a lamp and buzzer if any abnormalities should occur. In addition, countermeasures are indicated in 4 levels to help prevent major problems.



Maintenance Function

When the machine reaches the replacement intervals for oil and filters, the monitor panel will display lights to inform the operator.



Ground access to the filters

The oil filters of the transmission and the brake systems offer servicing from the ground.



Easy draining of transmission oil

Two drain ports are added to facilitate drain of oil in the piping.

Tiltable cab

The cab can be tilted rearward 32 degrees to provide easy maintenance/service for the engine and transmission.



Electric priming pump

The manual priming pump is replaced with the electric priming pump.

Battery disconnect switch

A standard disconnect switch allows a technician to disconnect the power supply before servicing the machine.



Hydraulically driven fans

Two hydraulically driven cooling fans are used for the radiator and charge air cooler. Both fans are reversible and are controlled separately.

Center-located operator seat

Placing the seat at the center of the operator's cabin provides a wide view of the working area.



New air suspension seat

A new high capacity air suspension seat with headrest is now standard. The air suspension seat dampens vibrations transmitted from the machine and reduces operator fatigue.



3 point seat belt

A three-point seat belt is standard equipment. The seat belt can be converted to a two-point lap belt.



Training seat

The cushion and back rest of the training seat are foldable. Folding the cushion allows the operator to come in and out of the cab and allows easy access to the recirculation filter of the air conditioner. Folding the backrest allows access to storage at the rear of the seat.

Low Noise Design

Operator's ear noise level : 73 dB(A)
 Dynamic noise level (outside): 108 dB(A)

The large cab is mounted with Komatsu's unique ROPS/FOPS viscous mounts. The low-noise engine, hydraulically driven fan, and hydraulic pumps are mounted with rubber cushions, and the cab sealing is designed to provide a quiet, low-vibration, dustproof, and comfortable operating environment.



Tilt-away steering column

The tiltable steering column and telescopic steering wheel allow the operator to set the steering wheel to the desired position. The tilt mechanism incorporates a spring-assist for easy adjustment.



Radio with AUX terminal

By connecting an auxiliary device to this plug, the operator can hear sound through the speakers in the cab.

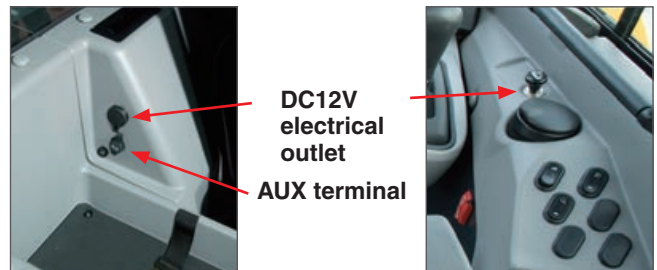

Two 12V electrical outlets

Two 12 volt DC outlets are included as standard in the operators cabin. A 12 volt cigarette lighter is installed on the front right side console and an additional 12 volt outlet is located in the rear right side behind the operator seat.

INFORMATION & COMMUNICATION TECHNOLOGY

ECO Guidance

The monitor panel provides guidance to the operator to help promote energy saving operation. The ECO Guidance function displays six (6) messages:

- Avoid Excessive Engine Idling
- Release the Hoist Lever
- Operating the Accelerator Pedal with Brake Actuated Lowers Fuel Economy
- Shift Up
- Avoid Operating the Accelerator Pedal with the Body Moving Down
- Avoid Hard Use of Steering



ECO gauge

The ECO gauge indicates the instantaneous fuel consumption rate during operation.

Operating the machine by keeping the gauge within the green zone leads to the energy-saving operation.

* Fuel consumption rate depends on the work load and accelerator pedal operation.



ECO gauge

Fuel consumption gauge

Energy saving operation guide

The operator can check the operation record, ECO Guidance record, and fuel consumption record.

The Operation Records indicate the status of the machine for the current day.

The ECO Guidance Records displays the number of occurrences of each guidance message. During operation, it is requested to reduce the number of occurrences of each guidance message in order to achieve energy-saving operation.

The Average Fuel Consumption Logs graph the fuel consumption for the previous 12 hours (based on service meter reading) and daily fuel consumption for the previous 7 days.



Operation Records



ECO Guidance Records

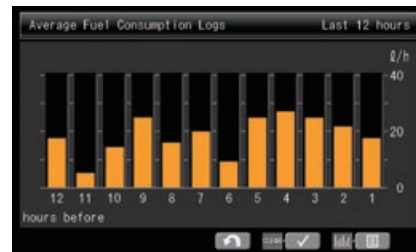

Average Fuel Consumption Logs

Machine Monitor

The machine monitor displays various machine information and allows for various settings of the machine.

Switch panel

The switch panel is used to select various LCD unit screens and the air conditioner control screen.

By using the switch panel, you can display various user menus on the LCD unit screen and perform the settings of the machine.

Large Multi-Lingual LCD Monitor

A large user-friendly color monitor provides excellent screen visibility through the use of a TFT liquid crystal display that can easily be read at various angles and lighting conditions. A keypad provides simple and easy navigation to machine operation information.

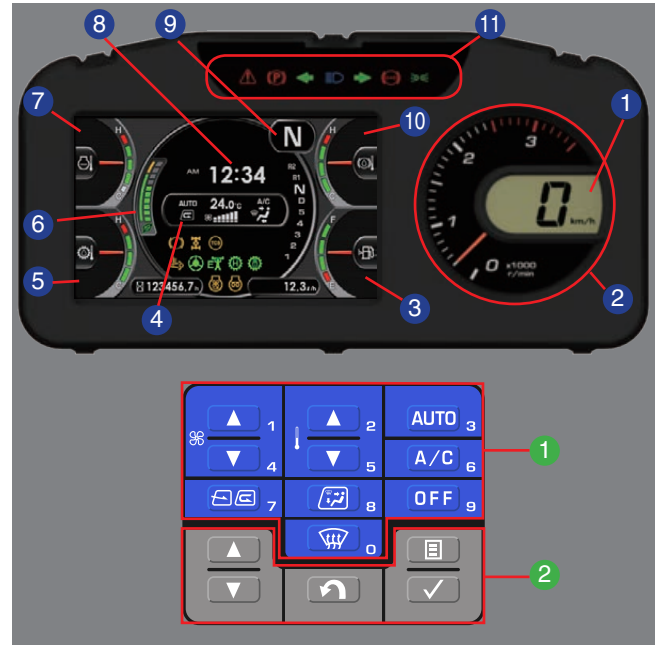

Machine monitor

- 1 Speed meter
- 2 Engine tachometer
- 3 Fuel gauge
- 4 Air conditioner display
- 5 Torque converter oil temperature gauge
- 6 ECO gauge
- 7 Engine water temperature gauge
- 8 Time display
- 9 Shift indicator
- 10 Retarder oil temperature gauge
- 11 LED indicator

Switch panel

- 1 Air conditioner switches / Numeral key pad
- 2 Function switches

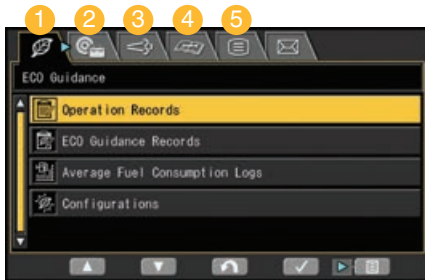

1 ECO Guidance

- Operation Records
- ECO guidance Records
- Average Fuel Consumption Logs
- Configurations

2 Machine setting / information

- Radiator fan reverse mode
- CAC fan reverse mode
- TCS setting etc.

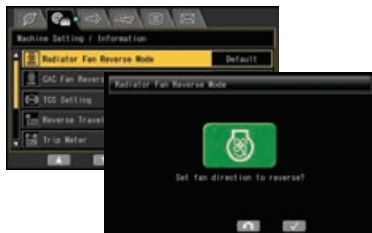

3 KDPF regeneration

- Setting for regeneration stop
- Operation of manual stationary regeneration

4 Maintenance

- Check and reset of various maintenance intervals



5 Monitor setting

- 25 Languages
- Rear view monitor setting
- Meter select
- Screen adjustments



GENERAL FEATURES

Color rearview monitoring system

The new color rear view camera & monitor are equipped as standard.



Hydro-pneumatic suspension

The front axle hydro-pneumatic suspension employs “De Dion” type design, allowing the machine to ride more smoothly over rough terrain. The rear-axles are mounted on a dynamic equalizer structure equipped with hydro-pneumatic suspension. The entire vehicle’s suspension delivers a comfortable ride and maximizes productivity.

Increase hitch height above ground

The bottom face of the hitch is higher than the bottom face of the differential gear of the front axle. The hitch height above ground is increased over the HM300-2.

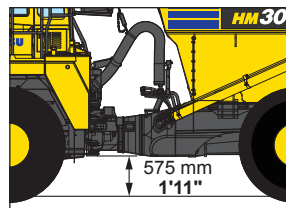

HM300-3

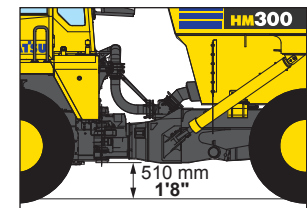

HM300-2

Short nose

A new layout of the cooling system allows for a shorter nose shape compared to the previous model, increasing the field of view to the operator.

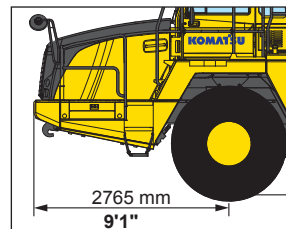

HM300-3

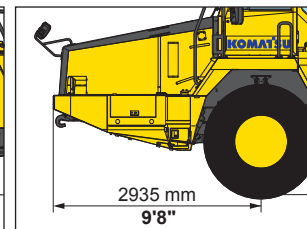

HM300-2

Hydraulically controlled wet multiple-disc brakes and retarder

The large-capacity, continuously cooled, wet-multiple disc brakes also function as a highly responsive retarder which gives the operator greater confidence at higher speeds when travelling downhill.

Retarder Absorbing Capacity (continuous descent):

392 kW **526 HP**

Komatsu CARE – Complimentary Scheduled Maintenance

- PM services for the earlier of 3 years / 2000 hours
- Performed by factory certified technicians
- Komatsu Genuine parts and fluids
- Significantly lowers your cost of ownership while maintaining high uptime and reliability
- Increases resale value and provides detailed maintenance records
- Extended PM services can be purchased beyond the complimentary period to provide additional peace of mind and maximize uptime



Komatsu CARE – Extended Coverage

- Extended Coverage can provide peace of mind by protecting customers from unplanned expenses that effect cash flow
- Purchasing extended coverage locks-in the cost of covered parts and labor for the coverage period and helps turn these into fixed costs



Komatsu Parts Support

- 24/7/365 to fulfill your parts needs
- 9 parts Distribution Centers strategically located across the U.S. and Canada
- Distributor network of more than 300 locations across U.S. and Canada to serve you
- Online part ordering through Komatsu eParts
- Remanufactured components with same-as-new warranties at a significant cost reduction



Komatsu Oil and Wear Analysis (KOWA)

- KOWA detects fuel dilution, coolant leaks, and measures wear metals
- Proactively maintain your equipment
- Maximize availability and performance
- Can identify potential problems before they lead to major repairs
- Reduce life cycle cost by extending component life

KOMTRAX EQUIPMENT MONITORING

GET THE WHOLE STORY WITH
KOMTRAX[®]

✓ WHAT

- KOMTRAX is Komatsu's remote equipment monitoring and management system
- KOMTRAX **continuously monitors and records** machine health and operational data
- Information such as fuel consumption, utilization, and a detailed history **aids in making repair or replacement decisions**

✓ WHEN

- Know when your machines are **running or idling** and make decisions that will improve your fleet utilization
- Detailed movement records ensure you know when and where your equipment is moved
- Up to date records allow you to **know when maintenance was done** and help you plan for future maintenance needs

✓ WHERE

- KOMTRAX data **can be accessed virtually anywhere** through your computer, the web or your smart phone
- Automatic alerts keep fleet managers up to date on the latest machine notifications

✓ WHO

- KOMTRAX is **standard** equipment on all Komatsu construction products

✓ WHY

- Knowledge is power - **make informed decisions** to manage your fleet better
- Knowing your idle time and fuel consumption will help maximize your machine efficiency
- **Take control of your equipment** - any time, anywhere

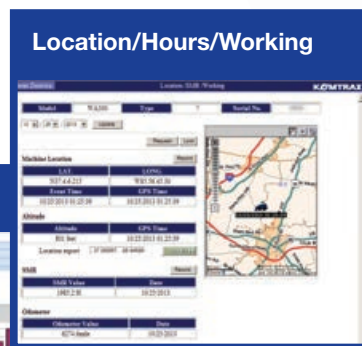
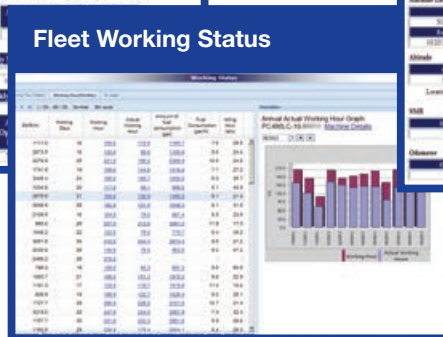

For construction and compact equipment.

For production and mining class machines.



ENGINE

Model..... Komatsu SAA6D125E-6*
 Type..... Water-cooled, 4-cycle
 Aspiration..... Komatsu variable geometry, turbo-charged,
 after-cooled, cooled EGR
 Number of cylinders..... 6
 Bore..... 125 mm **4.92"**
 Stroke..... 150 mm **5.91"**
 Piston displacement..... 11.04 ltr **674 in³**
 Horsepower:
 SAE J1995.....Gross 248 kW **332 HP**
 ISO 9249 / SAE J1349..... Net 242 kW **324 HP**
 Rated rpm.....2000 rpm
 Fan drive type.....Hydraulic
 Maximum torque..... 1680 N•m 171 kg•m **1239 ft lbs**
 Fuel system.....Direct injection
 Governor..... Electronically controlled
 Lubrication system:
 Method.....Gear pump, force-lubrication
 Filter.....Full-flow type
 Air cleaner..... Dry type with double elements and
 precleaner (cyclonpack type), plus dust indicator

*EPA Tier 4 Interim and EU stage 3B emissions certified



TRANSMISSION

Torque converter..... 3-elements, 1-stage, 2-phase
 Transmission..... Full-automatic, counter-shaft type
 Speed range..... 6 speeds forward and 2 reverse
 Lockup clutch..... Wet, single-disk clutch
 Forward..... Torque converter drive in 1st gear,
 direct drive in 1st lockup and all higher gears
 Reverse..... Torque converter drive and direct drive in all gear
 Shift control..... Electronic shift control with automatic
 clutch modulation in all gear
 Maximum travel speed..... 58.6 km/h **36.4 mph**



AXLES

Full time all wheel drive
 Final drive type..... Planetary gear
 Ratios:
 Differential..... 3.154
 Planetary..... 4.667



SUSPENSION SYSTEM

Front..... Hydro-pneumatic suspension
 Rear..... Combined hydro-pneumatic
 and rubber suspension system



STEERING SYSTEM

Type..... Articulated type, fully hydraulic power steering
 with two double-acting cylinders
 Supplementary steering..... Automatically actuated,
 electrically powered
 Standard.....ISO5010, SAE J1511
 Minimum turning radius, wall to wall..... 8.10 m **26' 7"**
 Articulation angle..... 45° each direction



CAB

Standard.....ISO3449 (FOPS)
 ISO3471 (ROPS)



BRAKES

Service brakes..... Full-hydraulic control, oil-cooled
 multiple-disc type on front and center axles
 Standard..... ISO3450
 Parking brake..... Spring applied, caliper disc type
 Retarder..... Front and center axle brakes act as retarder



MAIN FRAME

Type..... Articulated type, box-sectioned
 construction on front and rear
 Connected by strong torque tubes.



BODY

Capacity:
 Struck..... 13.4 m³ **17.5 yd³**
 Heaped (2:1, SAE)..... 17.1 m³ **22.4 yd³**
 Payload..... 28.0 metric tons **30.9 U.S. tons**
 Material..... 130 kg/mm² **184,925 psi**
 high tensile strength steel

Material thickness:
 Bottom..... 14 mm **0.55"**
 Front..... 8 mm **0.31"**
 Sides..... 12 mm **0.47"**

Target area
 (inside length x width) .. 5250 mm x 2685 mm **17' 3" x 8' 10"**
 Heating..... Exhaust heating (option)



HYDRAULIC SYSTEM

Hoist cylinder..... Twin, telescopic type
 Relief pressure..... 29.4 MPa 300 kg/cm² **4264 psi**
 Hoist time..... 10.5 sec



WEIGHT (APPROXIMATE)

Empty weight..... 24,910 kg **54,917 lbs**
 Gross vehicle weight..... 52,990 kg **116,823 lbs**
 Weight distribution:
 Empty: Front axle..... 57.0%
 Center axle..... 23.0%
 Rear axle..... 20.0%
 Loaded: Front axle..... 29.0%
 Center axle..... 36.5%
 Rear axle..... 34.5%



TIRES

Standard tire..... 23.5 R25



SERVICE REFILL CAPACITIES

Fuel tank..... 388.3 L **102.6 U.S. gal**
 Engine oil..... 35 L **9.2 U.S. gal**
 Torque converter, transmission and
 retarder cooling..... 98 L **25.9 U.S. gal**
 Differentials (total)..... 71.5 L **18.9 U.S. gal**
 Final drives (total)..... 23 L **6.1 U.S. gal**
 Hydraulic system..... 103 L **27.2 U.S. gal**
 Suspension (total)..... 10.4 L **2.7 U.S. gal**



DIMENSIONS

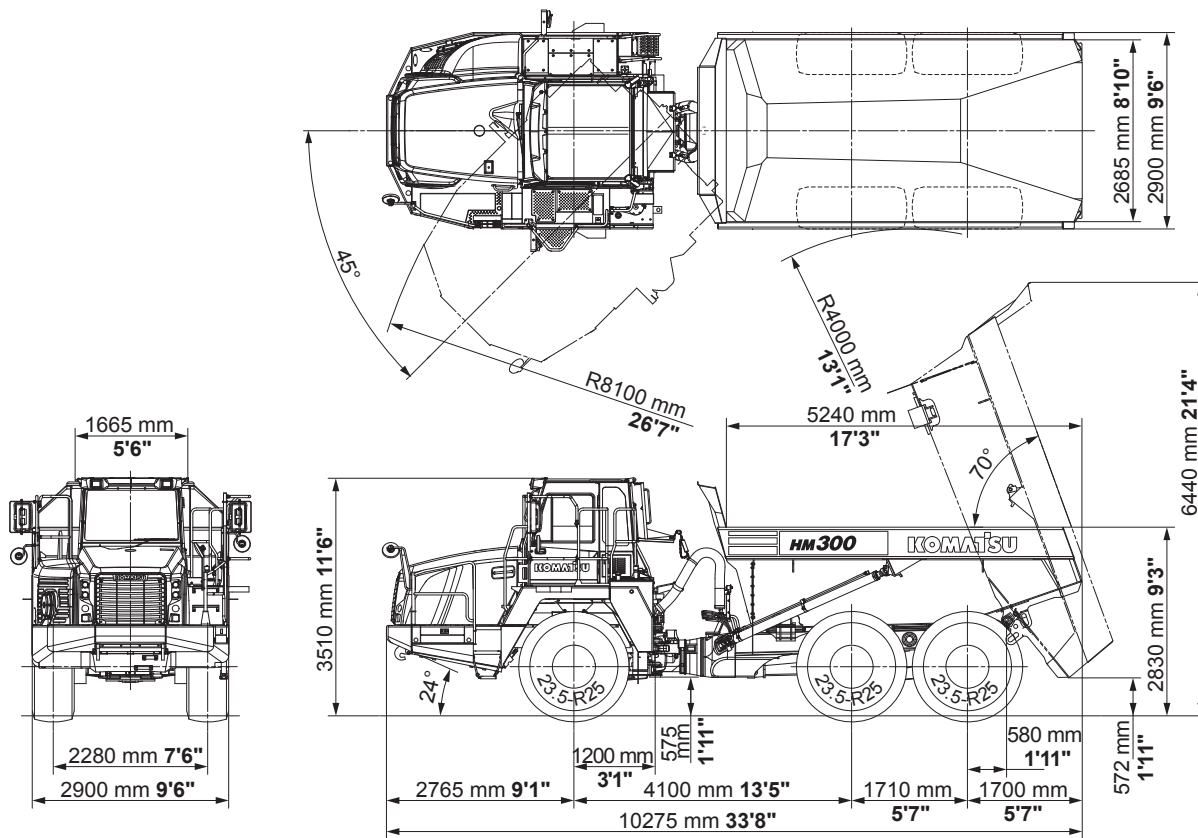

TRAVEL PERFORMANCE (Power mode)

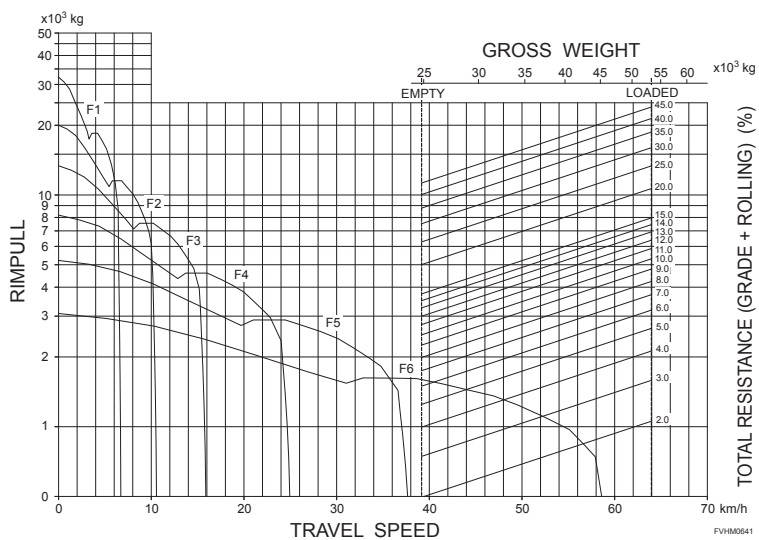

BRAKE PERFORMANCE

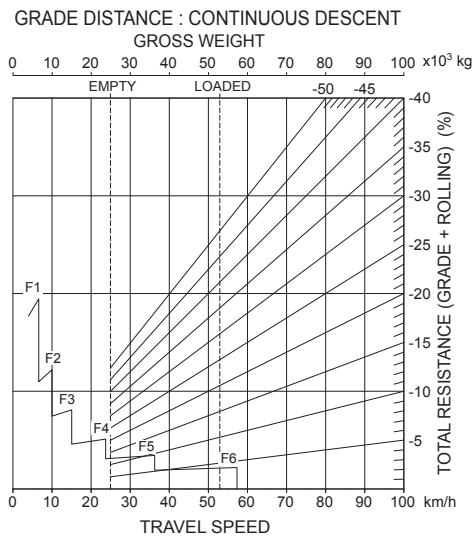



STANDARD EQUIPMENT FOR BASE MACHINE

- Air cleaner, dry type, double elements
- Air cleaner dust level indicator
- Air pre-cleaner
- Alternator, 60 A, 24 V
- Alarm, backup
- Anti-slip material on fenders
- Auxiliary steering system, automatic, electric
- Back-up lamp
- Batteries, 2 x 12 V/170 Ah
- Battery disconnect
- Body, 17.1 m³ **22.4 yd³**
- Centralized greasing
- Color rear view camera and monitor
- Coolant temperature alarm and lamp
- Dump counter
- ECO Guidance
- Electronic hoist control system
- Electric circuit breaker, 24 V
- Electric priming fuel pump
- Engine, Komatsu SAA6D125E-6
- Engine underguard
- Engine shutdown secondary switch
- Front view mirror
- Hazard lamps
- Hand rails for platform and ladder
- Headlights, front (high and low)
- Horn, electric
- Hydraulic driven cooling fan, for after cooler
- Hydraulic driven cooling fan, for radiator
- Hydropneumatic suspension, front and rear
- Interaxle lockup, wet disc clutch type, controlled by KTCS
- Komatsu Traction Control System (KTCS)
- Komatsu Diesel Particulate Filter (KDPF)
- Komatsu Variable Geometry Turbocharger (KVGIT)
- KOMTRAX[®] Level 4
- Ladders LH side
- Mud guards
- Parking brake
- Protective grille for rear window
- Propeller shaft guards, front and rear
- Provision for tailgate
- Rearview mirrors, LH and RH side
- Retarder/brake system
- Rims for 23.5 x 25, set of 6
- ROPS/FOPS cab Level 2
 - 2 x DC12V electrical outlets
 - 12V cigarette lighter
 - Air conditioner/Heater/Defroster
 - AM/FM radio with AUX terminal
 - Ashtray
- Color LCD/TFT multi-monitor
- Cup holder
- Floor mat
- Operator seat, reclining, air suspension type with 3-point retractable seat belt, 76 mm **3"** width lap belt, 50 mm **2"** width shoulder belt
- Passenger seat with 2-point retractable seat belt, 76 mm **3"** width
- Power window (LH)
- Space for lunch box
- Sliding window (RH)
- Steering wheel, tilt and telescopic
- Sun visor, front window
- Tilttable ROPS cab with FOPS, sound suppression type
 - Windshield washer and wiper, front and rear
- Starting motor, 7.5 kW
- Steering joint locking assembly
- Step (right side)
- Stop and tail lamps and turn signal lamps
- Tool box
- Transmission underguard
- Two mode engine power system (Economy and Power)
- Work lamps, LH and RH side



OPTIONAL EQUIPMENT

- Body exhaust heating
- Body liner
- Tail gate, scissors type

HM300-3

KOMATSU[®]

Note: All comparisons and claims of improved performance made herein are made with respect to the prior Komatsu model unless otherwise specifically stated.