

c

# Basic Pump

## Self Priming Centrifugal Pump

*Super*  
**T SERIES**

### Model T10A60S-B

### Size 10" x 10"



#### PUMP SPECIFICATIONS

**Size:** 10" x 10" (254 mm x 254 mm) Flanged.

**Casing:** Gray Iron 30.

Maximum Operating Pressure 99 psi (683 kPa).\*

**Semi-Open Type, Two Vane Impeller:** Ductile Iron 65-45-12.

Handles 3" (76,2 mm) Diameter Spherical Solids.

**Impeller Shaft:** Stainless Steel 17-4 PH.

**Shaft Sleeve:** Alloy Steel 4130.

**Replaceable Front Wear Plate:** Ductile Iron 80-55-06.

**Replaceable Rear Wear Plate:** Carbon Steel 1026.

**Removable Clean-out Cover Plate:** Gray Iron 30; 9 lbs. (4 kg).

**Flap Valve:** Neoprene w/Steel Reinforcing.

**Seal Plate:** Gray Iron 30.

**Bearing Housing:** Gray Iron 30.

**Radial and Thrust Bearings:** Open Double Row Ball.

**Bearing and Seal Cavity Lubrication:** SAE 30 Non-Detergent Oil.

**Suction Flange:** Gray Iron 30.

**Suction Head:** Gray Iron 30.

**Gaskets:** Buna-N, PTFE, Cork, and Rubber.

**O-Rings:** Buna-N.

**Hardware:** Standard Plated Steel.

**Brass Pressure Relief Valve.**

**Bearing and Seal Cavity Oil Level Sight Gauges.**

**Optional Equipment:** Metal Bellows Seal. Automatic Air

Release Valve. High Pump Temperature Shutdown Kit.

120V/240V Casing Heater. Continuous Vane Ductile Iron

Impeller w/Self-Cleaning Ductile Iron Wear Plate.

Gray Iron 30 Spool Flanges:

10" ASA Discharge.

250 mm DIN 2527 (PN 16) Suction and Discharge

(Specify Model T10A60S-B /FM).

*\*Consult Factory for Applications Exceeding Maximum Pressure and/or Temperature Indicated.*



Shown with Optional Discharge Spool Flange (Suction/Discharge Spool Flanges Available in ASA or DIN Standard Sizes).

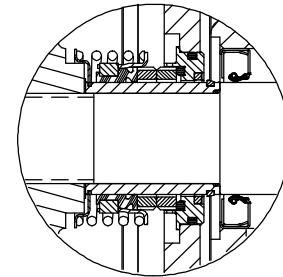
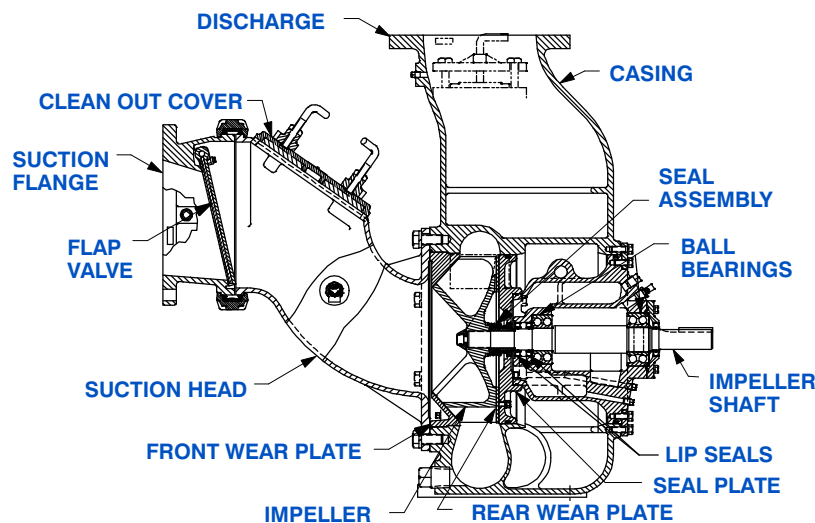

#### SEAL DETAIL

Cartridge Type, Mechanical, Oil-Lubricated, Double Floating, Self-Aligning. Silicon Carbide Rotating and Stationary Faces. Stainless Steel 316 Stationary Seat. Fluorocarbon Elastomers (DuPont Viton® or Equivalent). Stainless Steel 18-8 Cage and Spring. Maximum Temperature of Liquid Pumped, 160°F (71°C).\*



THE GORMAN-RUPP COMPANY • MANSFIELD, OHIO

GORMAN-RUPP OF CANADA LIMITED • ST. THOMAS, ONTARIO, CANADA

www.grpumps.com

Specifications Subject to Change Without Notice

Printed in U.S.A.

**Specification Data**

SECTION 55, PAGE 2410

**APPROXIMATE DIMENSIONS and WEIGHTS**

**NET WEIGHT: 1440 LBS. (653 KG.)\***  
**SHIPPING WEIGHT: 1590 LBS. (721 KG.)\***  
**EXPORT CRATE: 70.3 CU. FT. (2 CU. M.)**  
**\*ADD 71 LBS. (32,2 KG.) W/DISCH SPOOL FLANGE**

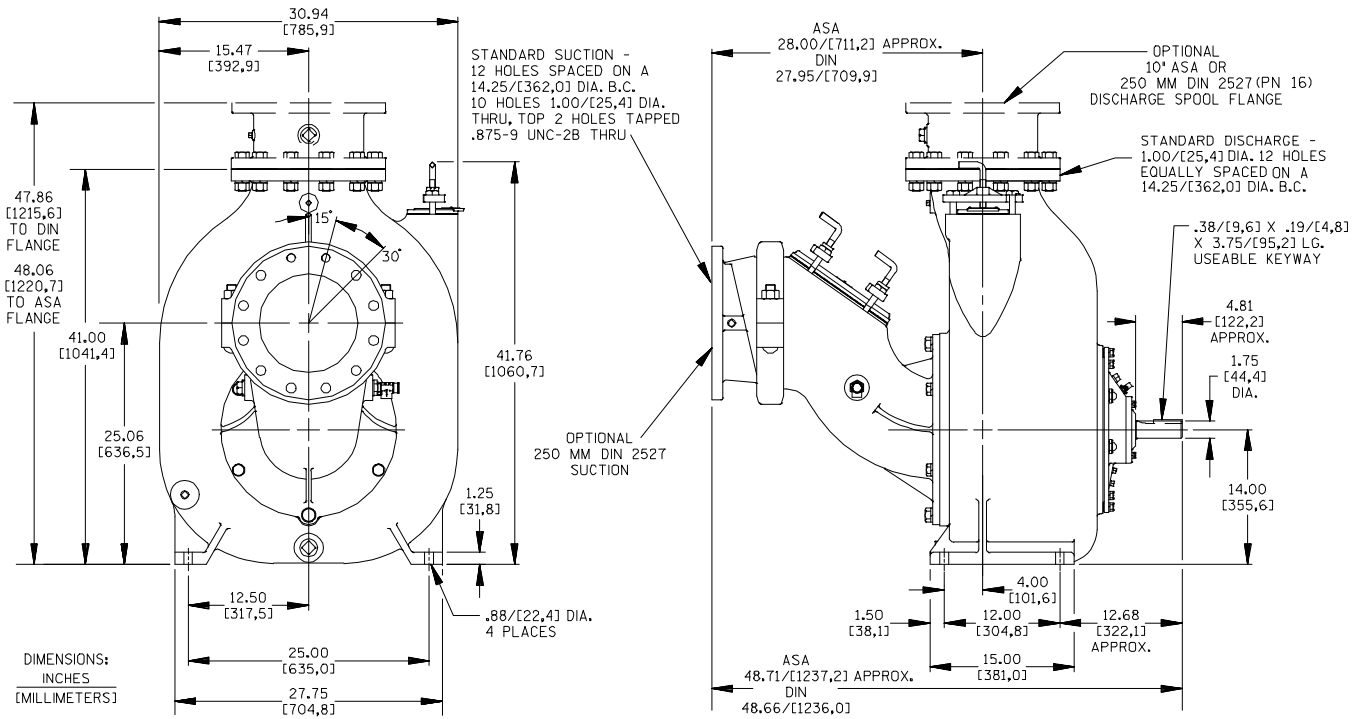

**OPTIONAL ASA OR DIN STANDARD SPOOL FLANGES AVAILABLE**

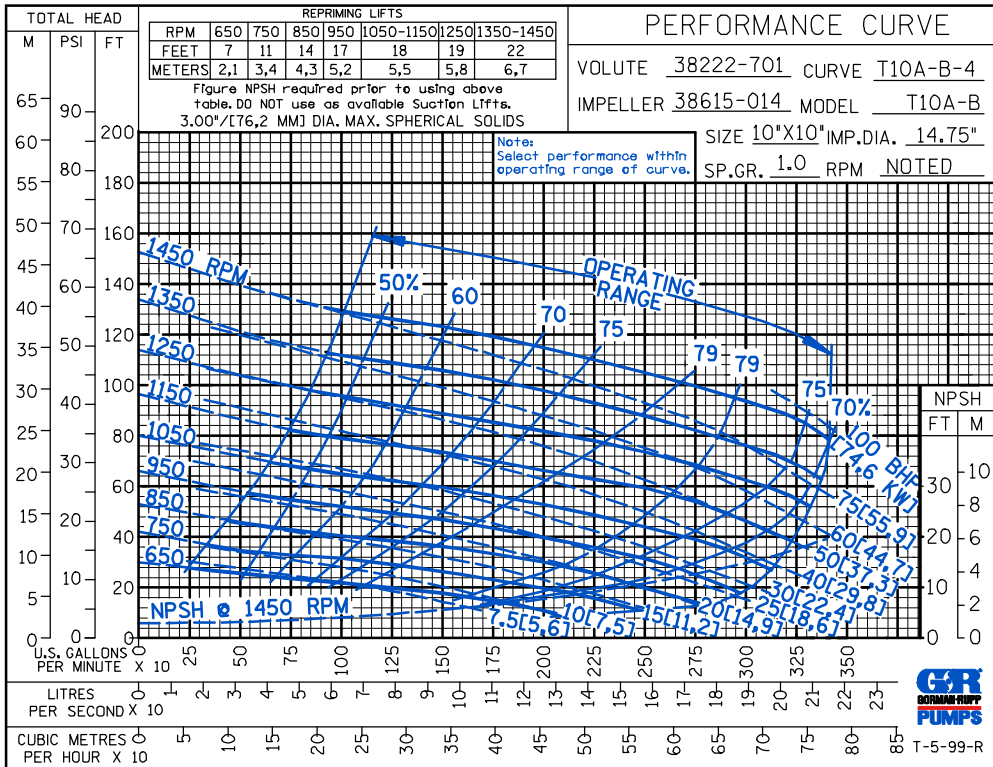

**THE GORMAN-RUPP COMPANY • MANSFIELD, OHIO**

GORMAN-RUPP OF CANADA LIMITED • ST. THOMAS, ONTARIO, CANADA

Specifications Subject to Change Without Notice

Printed in U.S.A.

CDS

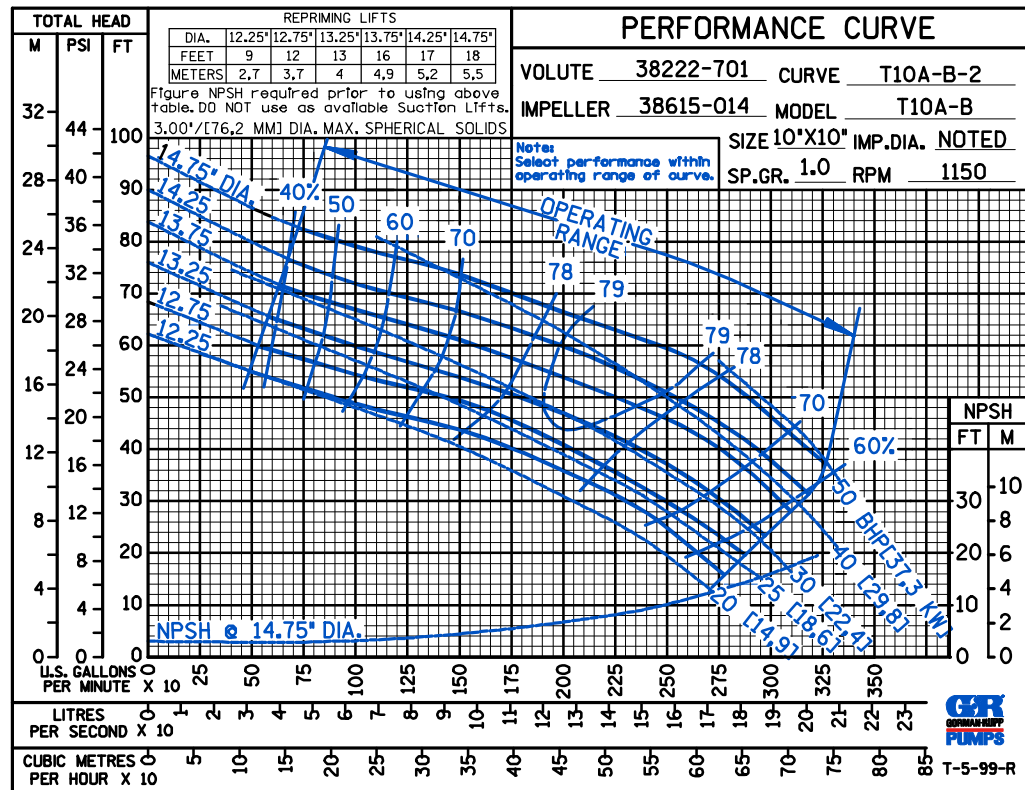
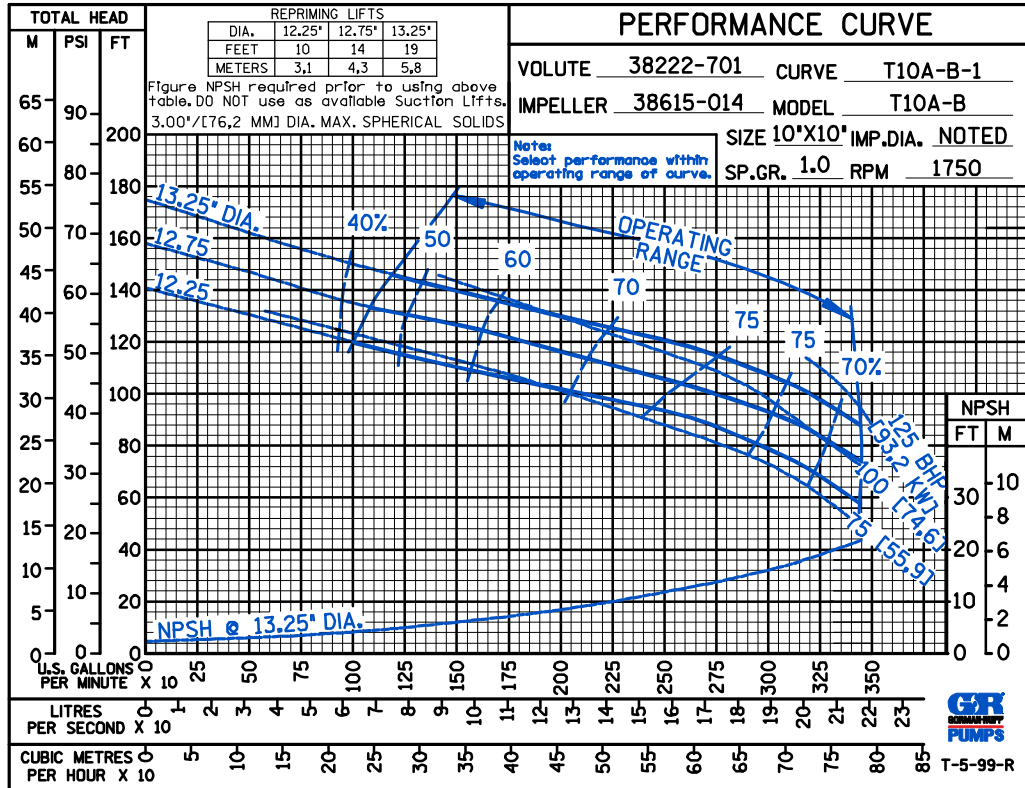

THE GORMAN-RUPP COMPANY • MANSFIELD, OHIO

GORMAN-RUPP OF CANADA LIMITED • ST. THOMAS, ONTARIO, CANADA

Specifications Subject to Change Without Notice

Printed in U.S.A.

CDS

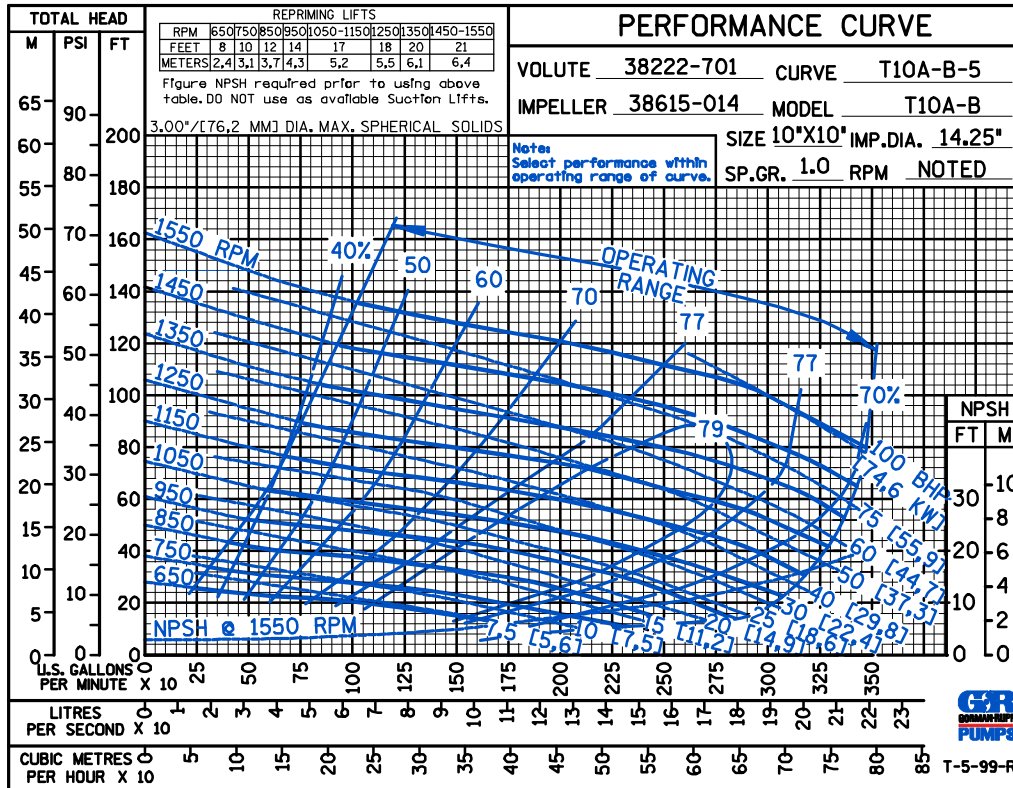
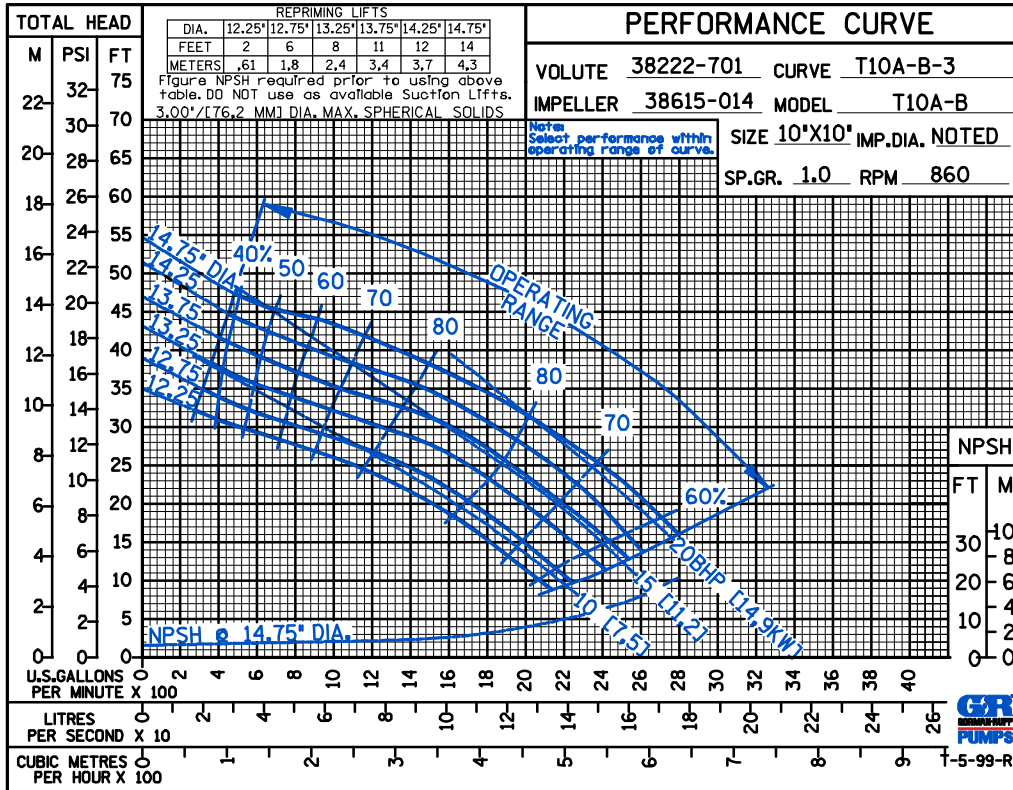

THE GORMAN-RUPP COMPANY • MANSFIELD, OHIO

GORMAN-RUPP OF CANADA LIMITED • ST. THOMAS, ONTARIO, CANADA

Specifications Subject to Change Without Notice

Printed in U.S.A.

CDS

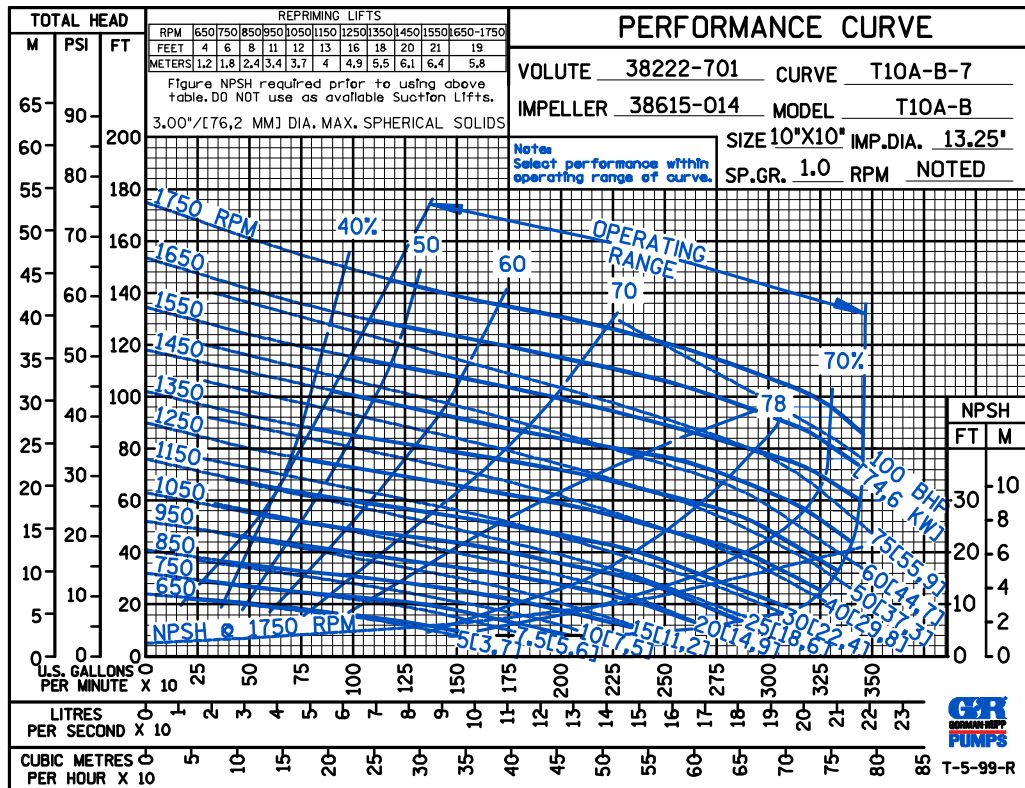
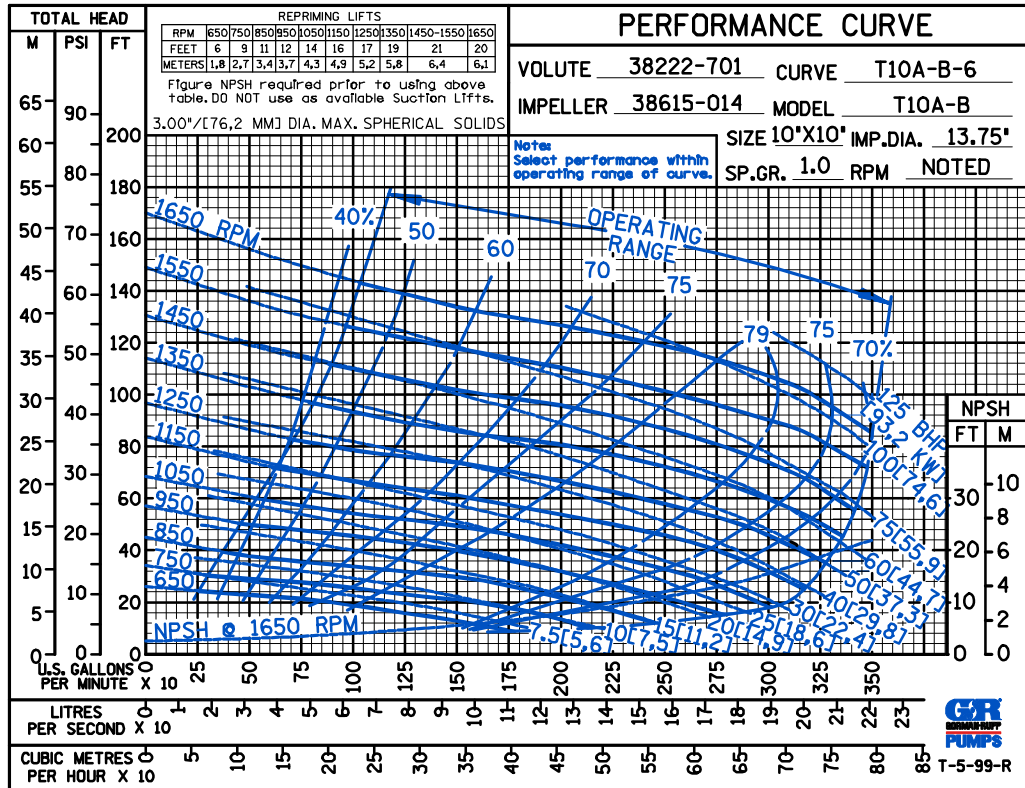

THE GORMAN-RUPP COMPANY • MANSFIELD, OHIO

GORMAN-RUPP OF CANADA LIMITED • ST. THOMAS, ONTARIO, CANADA

Specifications Subject to Change Without Notice

Printed in U.S.A.

CDS

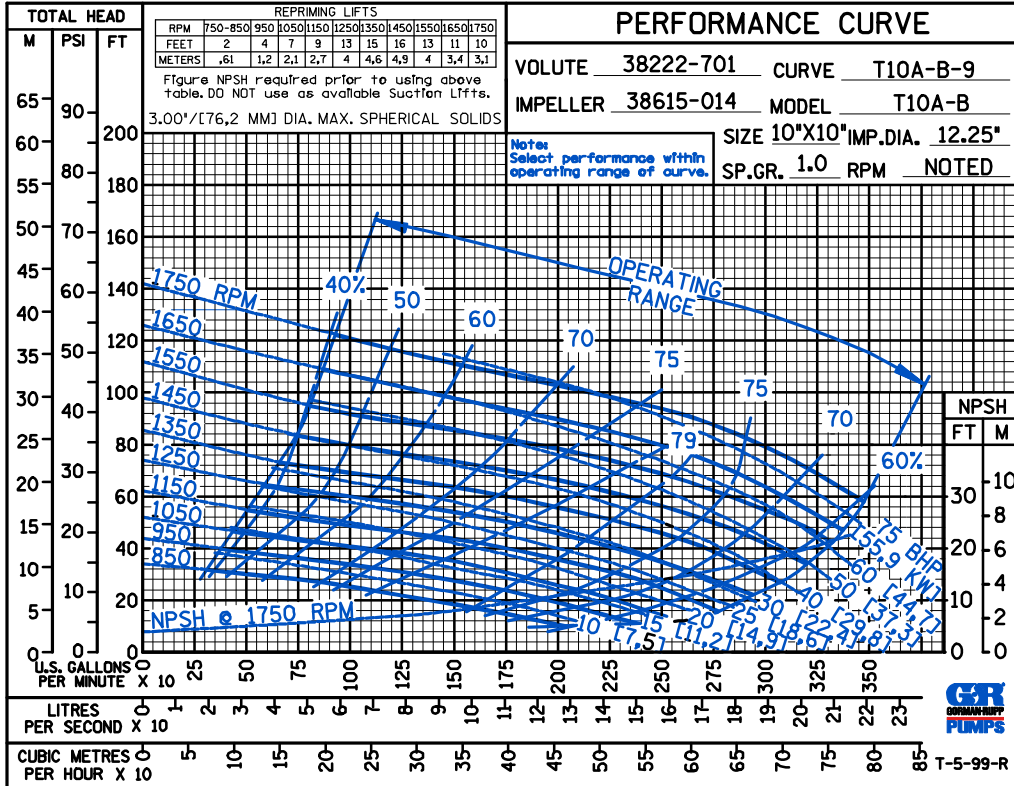
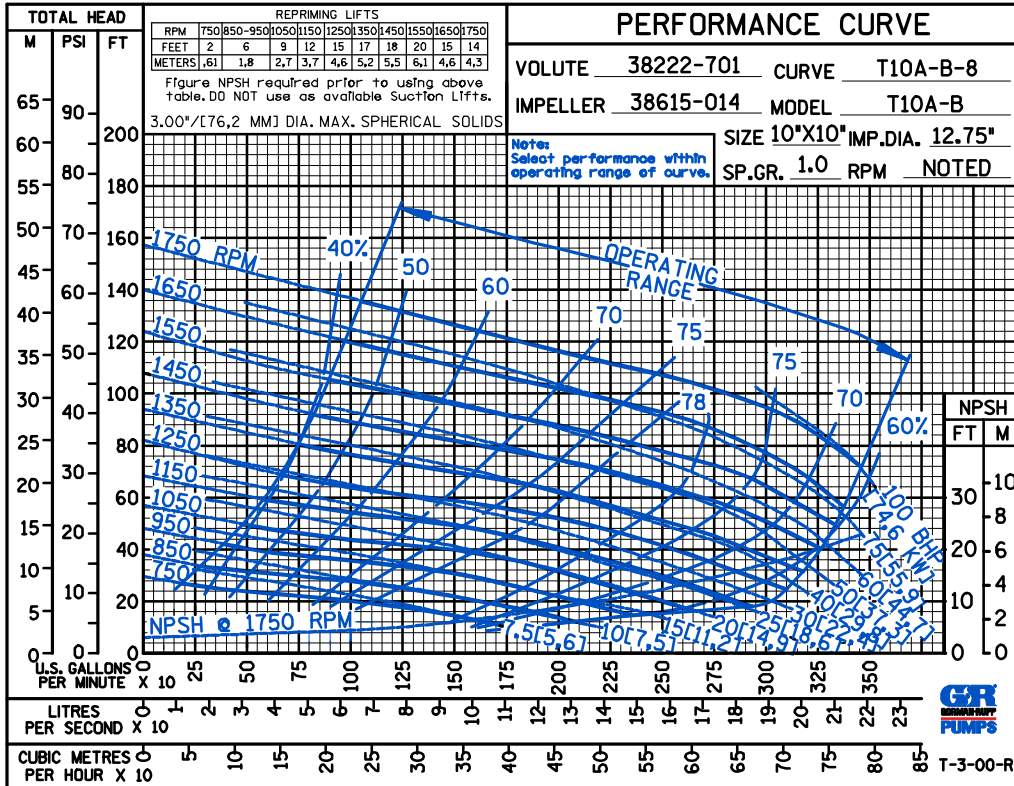

THE GORMAN-RUPP COMPANY • MANSFIELD, OHIO

GORMAN-RUPP OF CANADA LIMITED • ST. THOMAS, ONTARIO, CANADA

Specifications Subject to Change Without Notice

Printed in U.S.A.

CDS

50 HERTZ

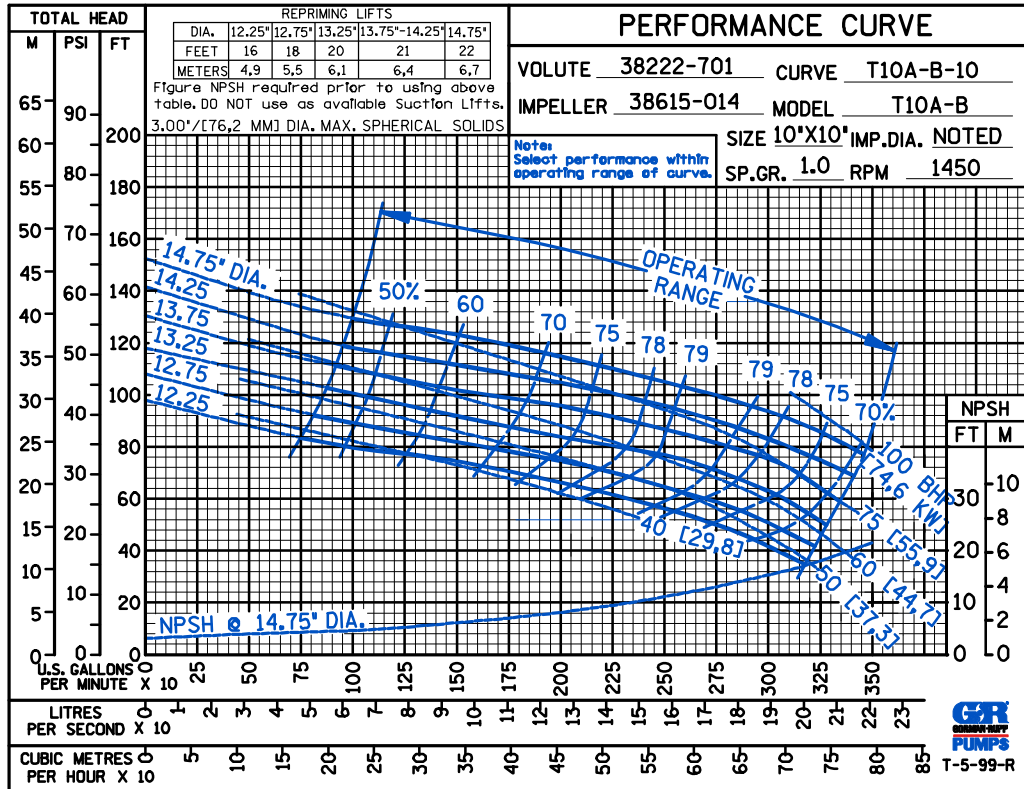

50 HERTZ

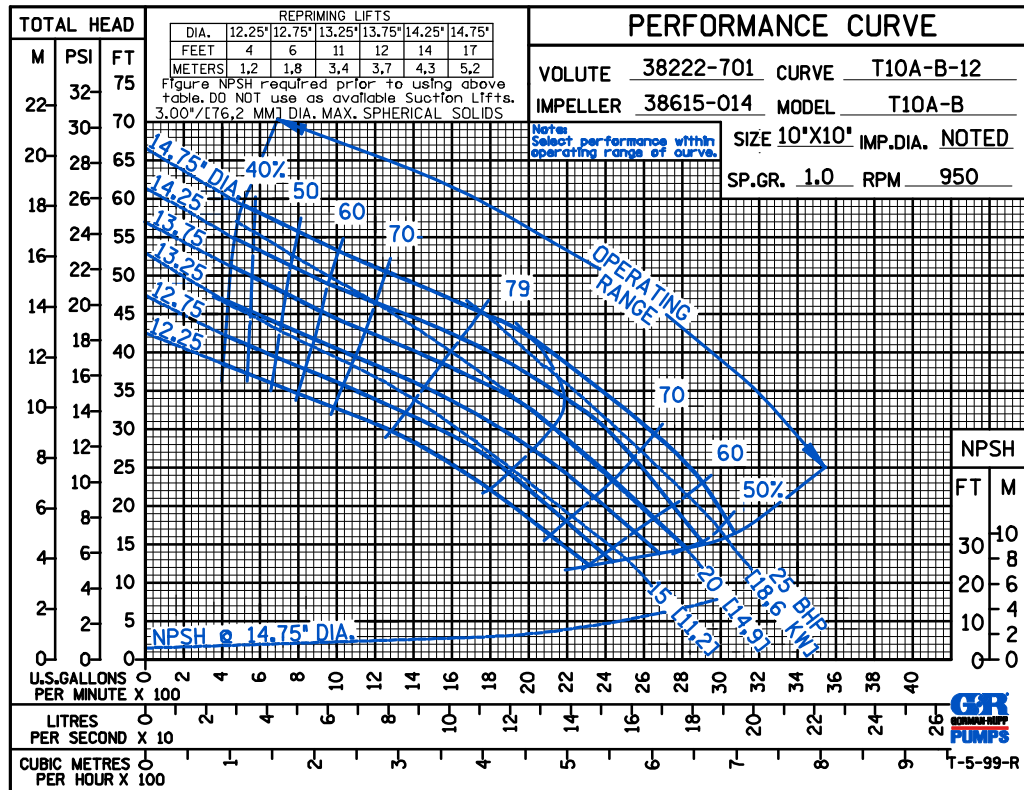

THE GORMAN-RUPP COMPANY • MANSFIELD, OHIO

GORMAN-RUPP OF CANADA LIMITED • ST. THOMAS, ONTARIO, CANADA

Specifications Subject to Change Without Notice

Printed in U.S.A.

D S

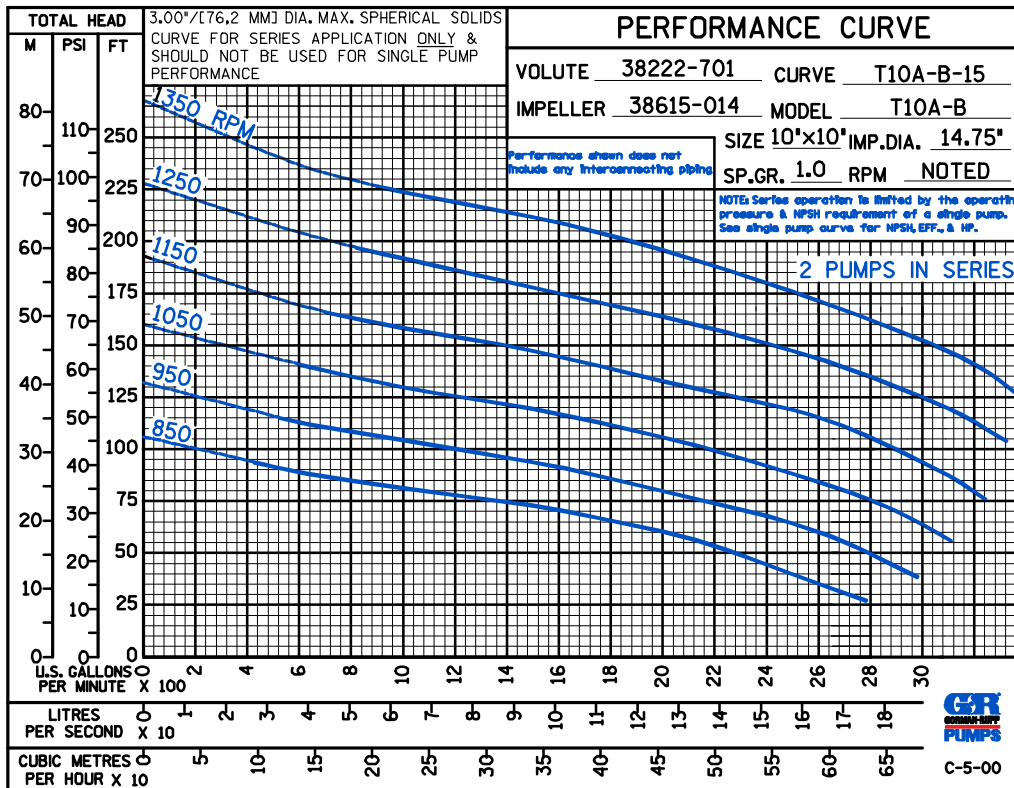
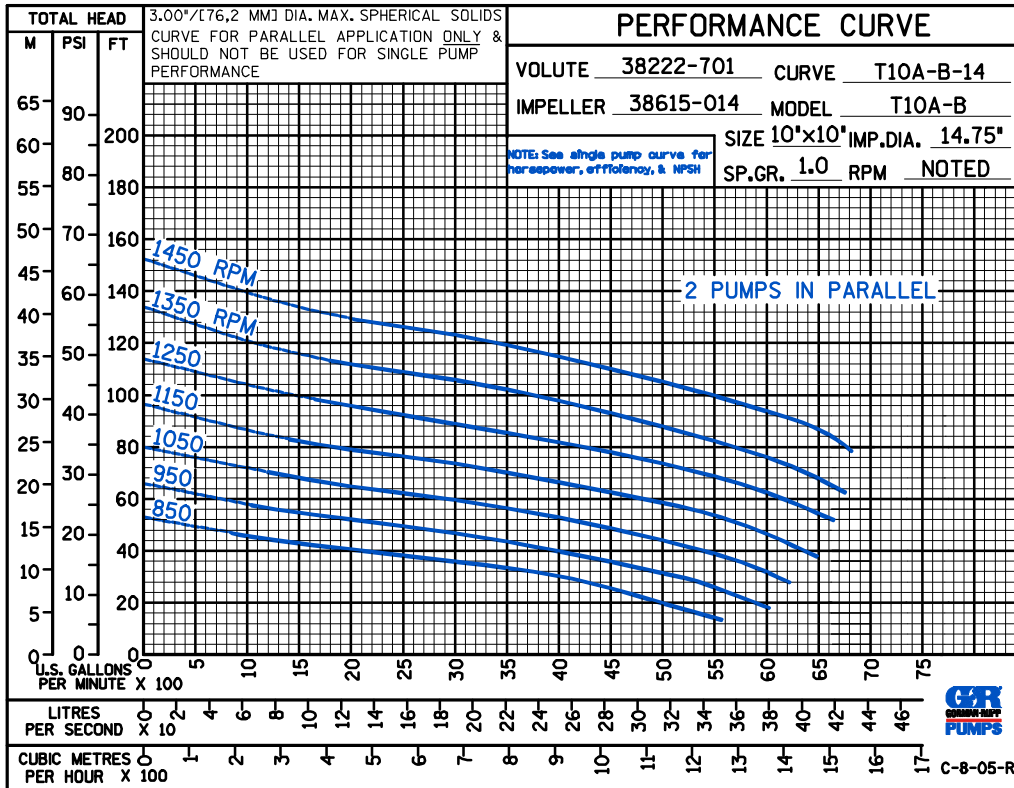

THE GORMAN-RUPP COMPANY • MANSFIELD, OHIO

GORMAN-RUPP OF CANADA LIMITED • ST. THOMAS, ONTARIO, CANADA

Specifications Subject to Change Without Notice

Printed in U.S.A.



