

CDS

Self Priming Centrifugal Pump

**Super
T SERIES**

VARIOUS PATENTS APPLY

Model T3A61S-B**Size 3" x 3"****PUMP SPECIFICATIONS****Size:** 3" x 3" (76 mm x 76 mm) NPT - Female.**Casing:** Gray Iron 30.

Maximum Operating Pressure 86 psi (593 kPa).*

Semi-Open Type, Two Vane Impeller: Stainless Steel 316.

Handles 2 1/2" (63,5 mm) Diameter Spherical Solids.

Impeller Shaft: Stainless Steel 17-4 PH.**Replaceable Wear Plate:** Stainless Steel 316.**Removable Adjustable Cover Plate:** Gray Iron 30; 35 lbs. (16 kg).**Flap Valve:** Neoprene w/Nylon and Steel Reinforcing.**Seal Plate:** Stainless Steel 316.**Bearing Housing:** Gray Iron 30.**Radial and Thrust Bearings:** Open Single Row Ball.**Bearing and Seal Cavity Lubrication:** SAE 30 Non-Detergent Oil.**Flanges:** Gray Iron 30.**Gaskets:** Buna-N w/Compressed Synthetic Fibers, Vegetable Fiber, PTFE, Cork and Rubber.**O-Rings:** Buna-N.**Internal Wetted Hardware:** Stainless Steel 316.**External Hardware:** Standard Plated Steel.**Pressure Relief Valve:** Stainless Steel 316.**Bearing and Seal Cavity Oil Level Sight Gauges.****Optional Equipment:** Automatic Air Release Valve. Metal Bellows Seal. Stainless Steel CD4MCu Impeller, Seal Plate and Wear Plate. 120V/240V Casing Heater. High Pump Temperature Shutdown Kit. Self-Cleaning Wear Plate.

Gray Iron 30 Suction and Discharge Spool Flanges:

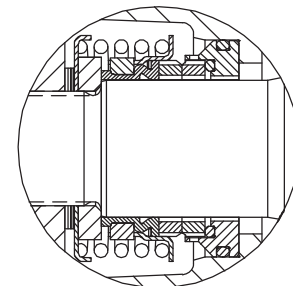
3" ASA (**Specify Model T3A61S-B /F**).80 mm DIN 2527 (PN 16) (**Specify Model T3A61S-B /FM**).**Consult Factory for Applications Exceeding Maximum Pressure and/or Temperature Indicated.***DISCHARGE****FLANGE****FLAP****VALVE****SUCTION****FLANGE****COVER****PLATE****WEAR****PLATE****IMPELLER****SEAL****ASSEMBLY****LIP****SEALS****IMPELLER****SHAFT****IMPELLER****IMPELLER****IMPELLER****IMPELLER****IMPELLER****IMPELLER****IMPELLER****IMPELLER****IMPELLER****IMPELLER****IMPELLER****IMPELLER****CASING****SEAL****PLATE****BALL****BEARINGS****IMPELLER****SHAFT****IMPELLER****IMPELLER****IMPELLER****IMPELLER****IMPELLER****IMPELLER****IMPELLER****IMPELLER****IMPELLER****IMPELLER****IMPELLER****IMPELLER****IMPELLER****IMPELLER****IMPELLER****IMPELLER****IMPELLER****Shown with Optional Suction & Discharge Spool Flanges (Available in ASA or DIN Standard Sizes).****SEAL DETAIL**

Mechanical, Oil-Lubricated, Double Floating, Self-Aligning. Silicon Carbide Rotating and Stationary Faces. Stainless Steel 316 Stationary Seat. Fluorocarbon Elastomers (DuPont Viton® or Equivalent). Stainless Steel 18-8 Cage and Spring. Maximum Temperature of Liquid Pumped, 160°F (71°C).*

**THE GORMAN-RUPP COMPANY • MANSFIELD, OHIO**

GORMAN-RUPP OF CANADA LIMITED • ST. THOMAS, ONTARIO, CANADA

www.grpumps.com

Specifications Subject to Change Without Notice

Printed in U.S.A.

Specification Data

SECTION 55, PAGE 2020

APPROXIMATE DIMENSIONS and WEIGHTS

NET WEIGHT: 420 LBS. (191 KG.)*
SHIPPING WEIGHT: 468 LBS. (212 KG.)*
EXPORT CRATE: 19.3 CU. FT. (0,55 CU. M.)
***ADD 10 LBS. (4,5 KG.) W/EACH SPOOL FLANGE**

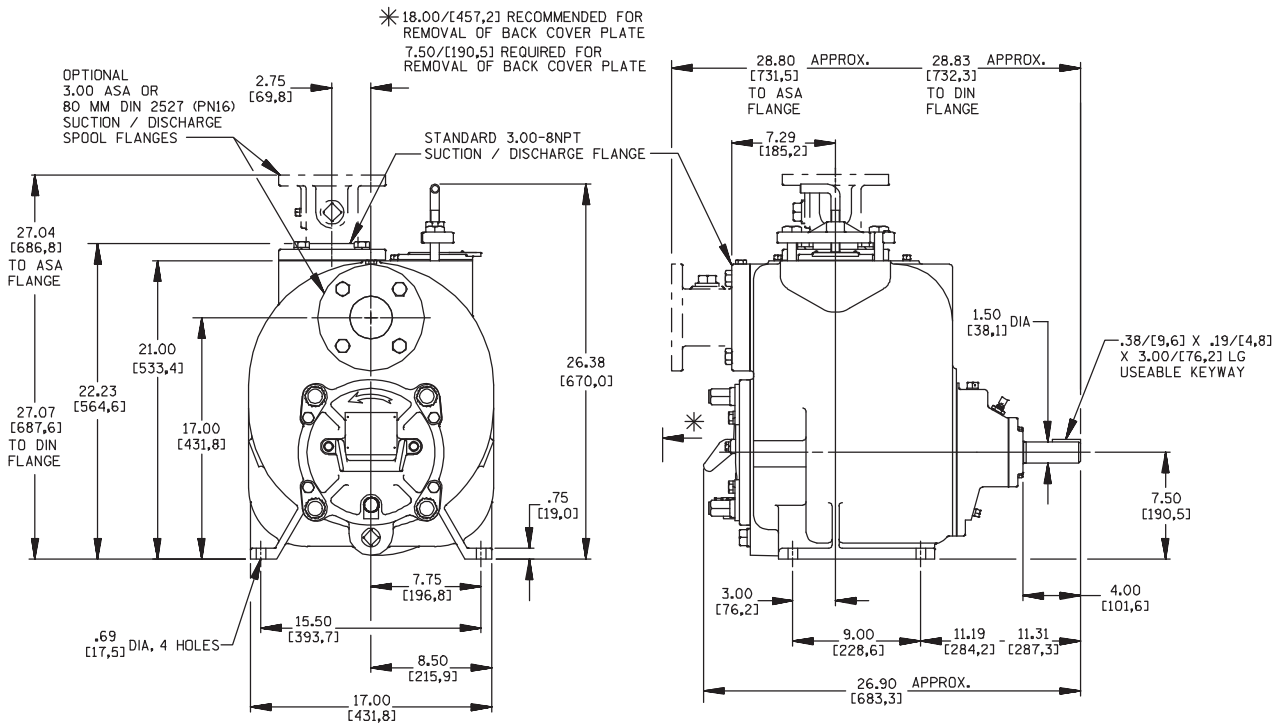

OPTIONAL ASA OR DIN STANDARD SUCTION & DISCHARGE SPOOL FLANGES AVAILABLE

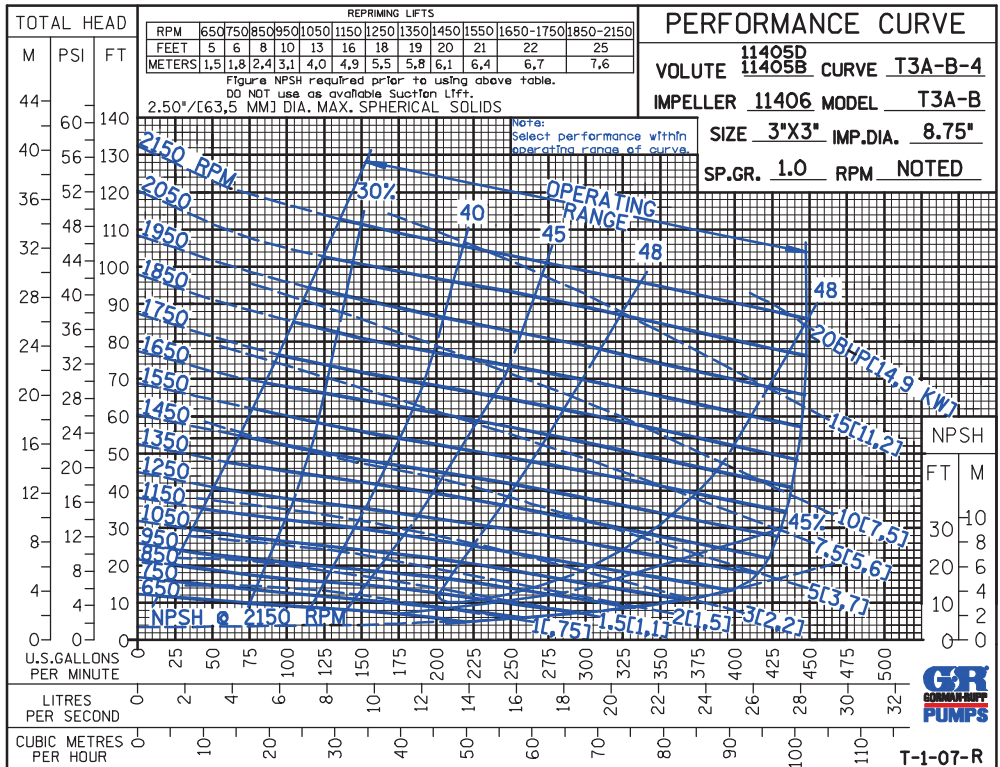

THE GORMAN-RUPP COMPANY • MANSFIELD, OHIO

GORMAN-RUPP OF CANADA LIMITED • ST. THOMAS, ONTARIO, CANADA

Specifications Subject to Change Without Notice

Printed in U.S.A.

CDS

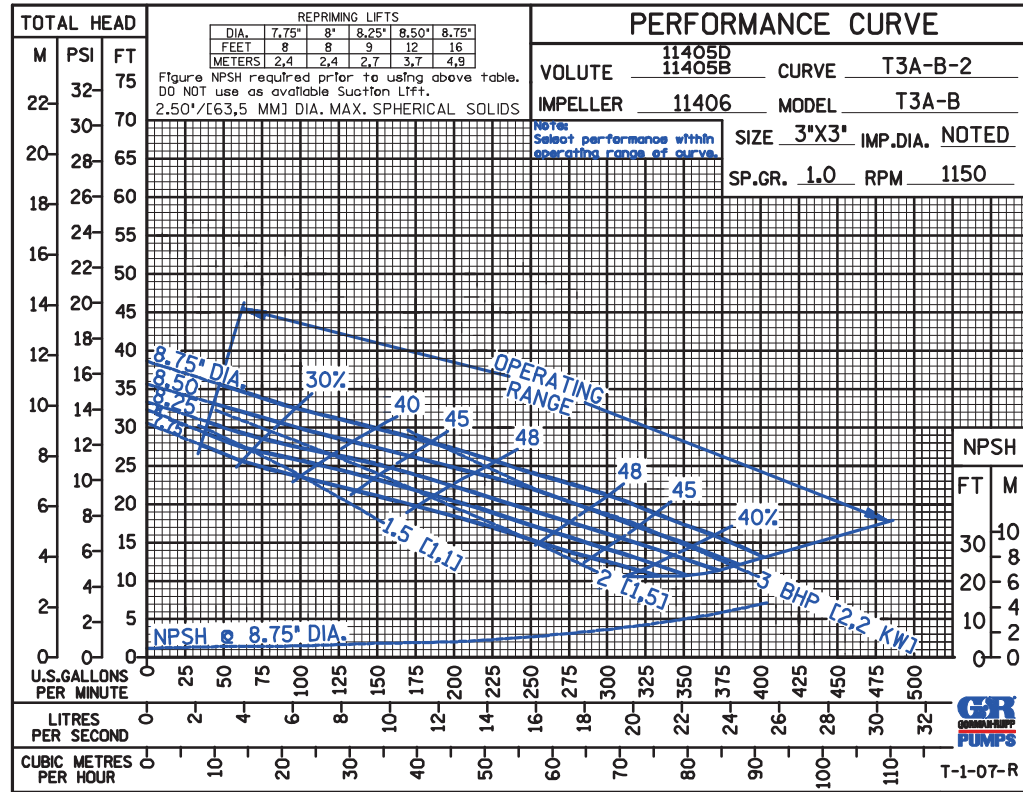
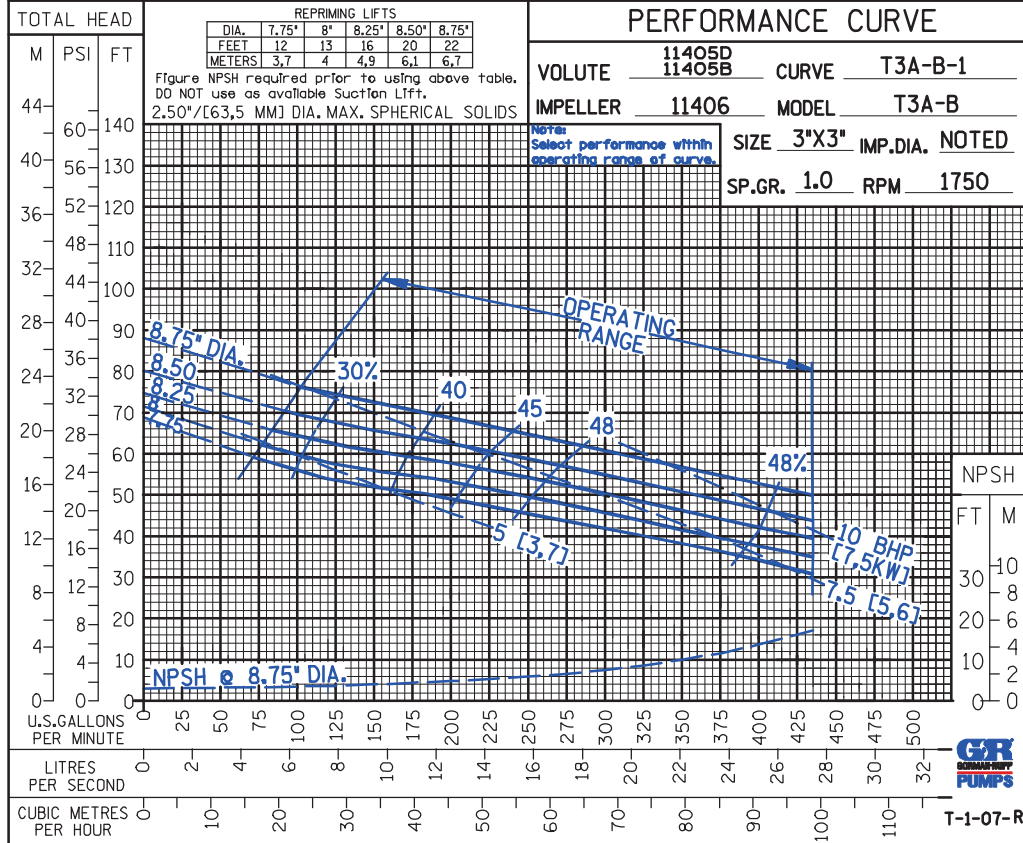

THE GORMAN-RUPP COMPANY • MANSFIELD, OHIO

GORMAN-RUPP OF CANADA LIMITED • ST. THOMAS, ONTARIO, CANADA

Specifications Subject to Change Without Notice

Printed in U.S.A.

CDS

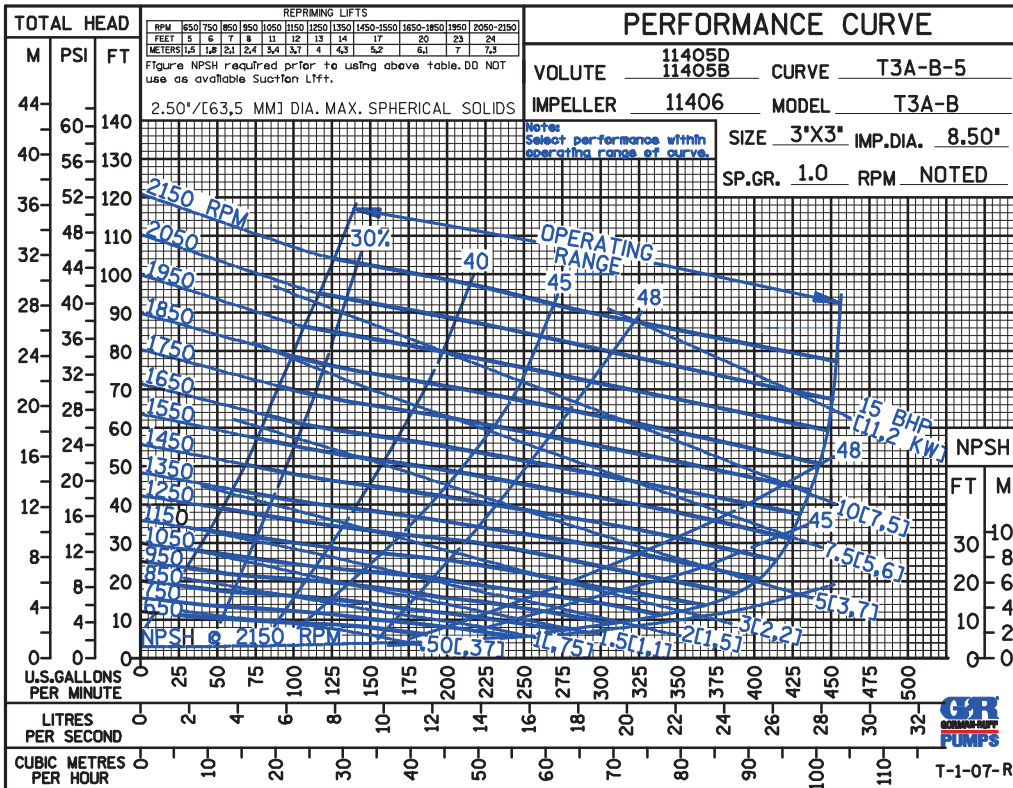
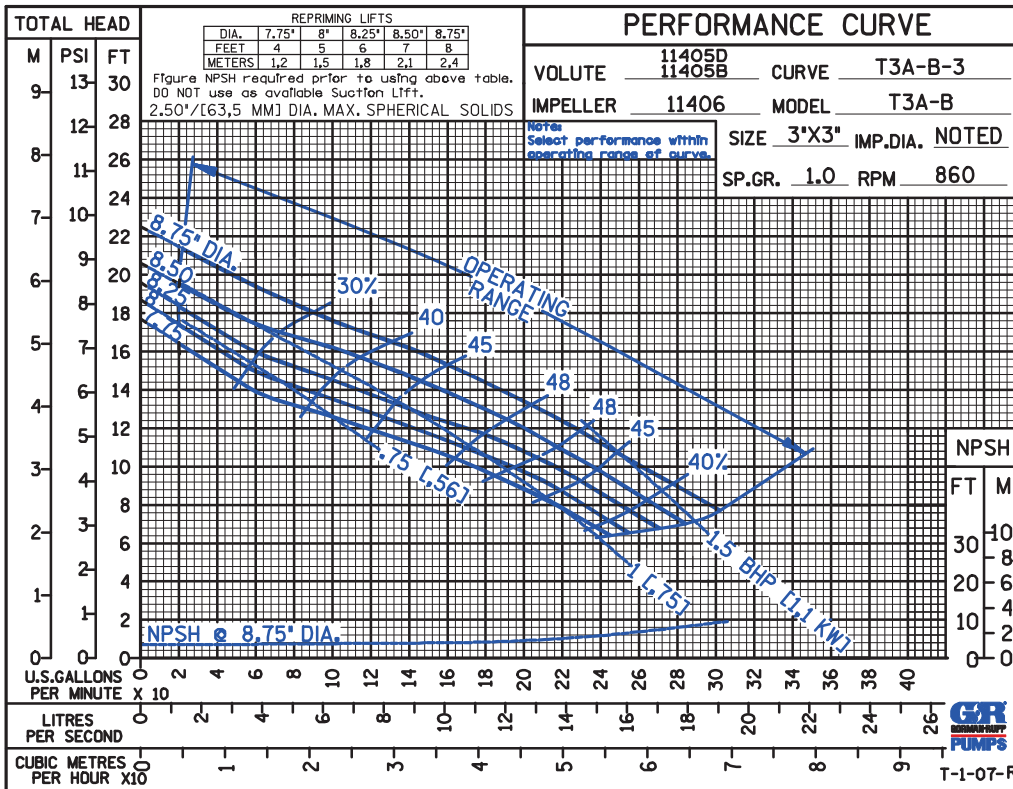

THE GORMAN-RUPP COMPANY • MANSFIELD, OHIO

GORMAN-RUPP OF CANADA LIMITED • ST. THOMAS, ONTARIO, CANADA

Specifications Subject to Change Without Notice

Printed in U.S.A.

CDS

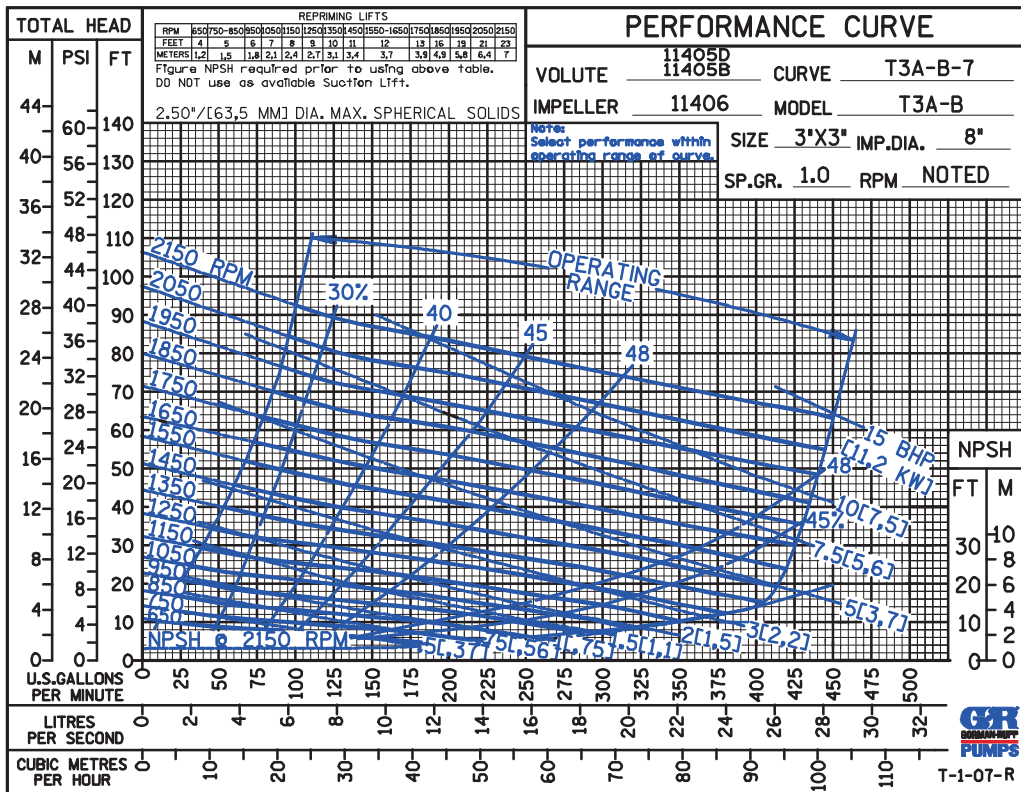
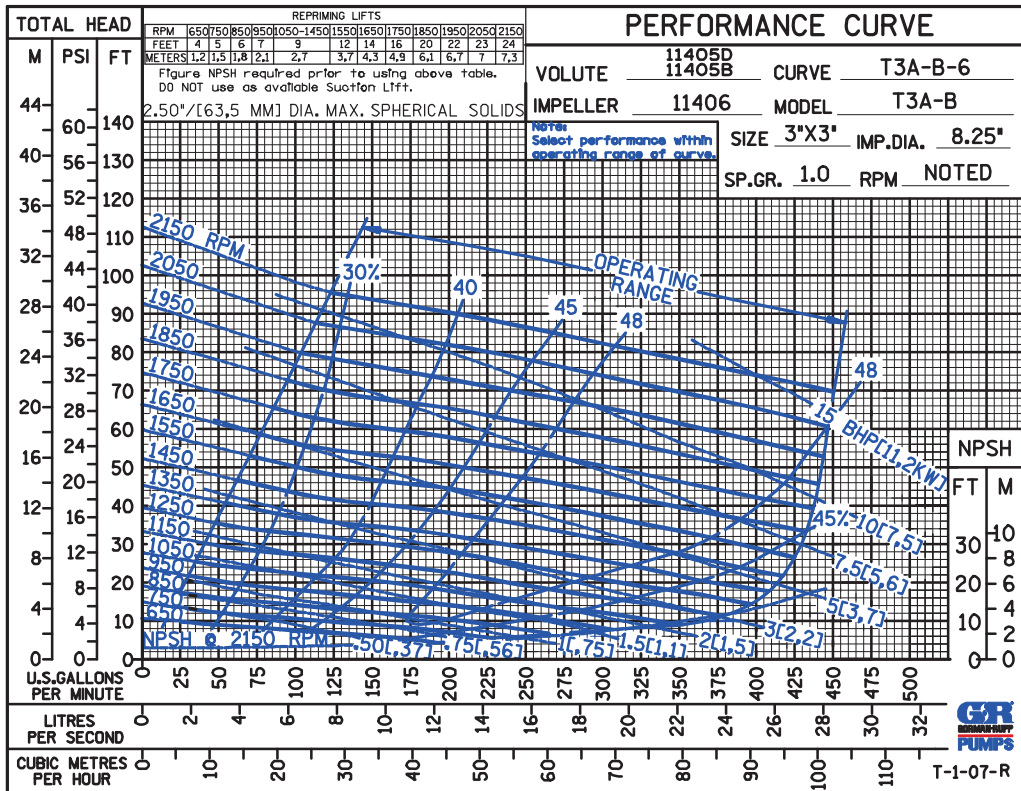

THE GORMAN-RUPP COMPANY • MANSFIELD, OHIO

GORMAN-RUPP OF CANADA LIMITED • ST. THOMAS, ONTARIO, CANADA

Specifications Subject to Change Without Notice

Printed in U.S.A.

CDS

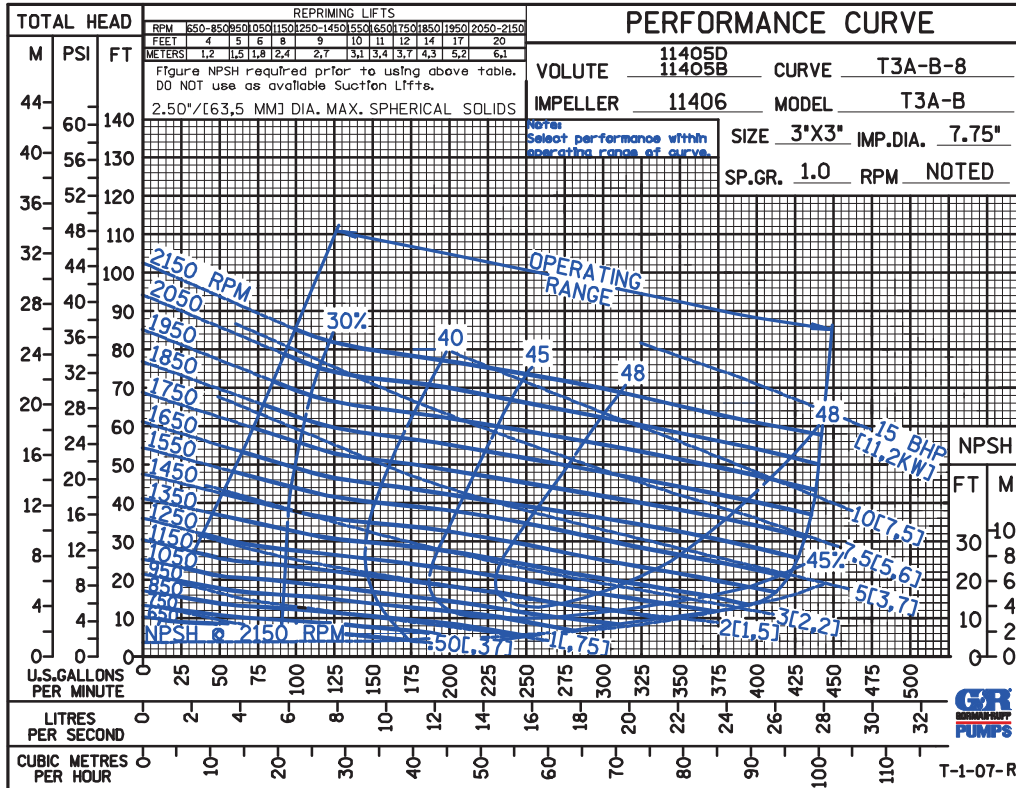

50 HERTZ

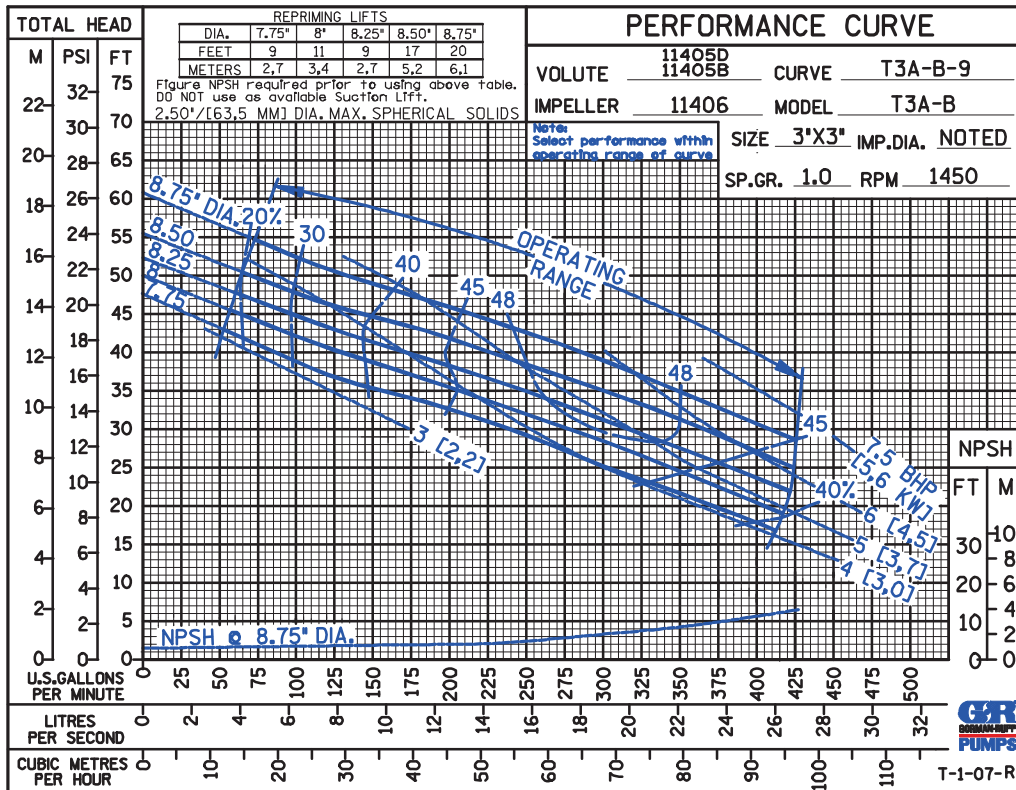

THE GORMAN-RUPP COMPANY • MANSFIELD, OHIO

GORMAN-RUPP OF CANADA LIMITED • ST. THOMAS, ONTARIO, CANADA

Specifications Subject to Change Without Notice

Printed in U.S.A.

CDS

50 HERTZ

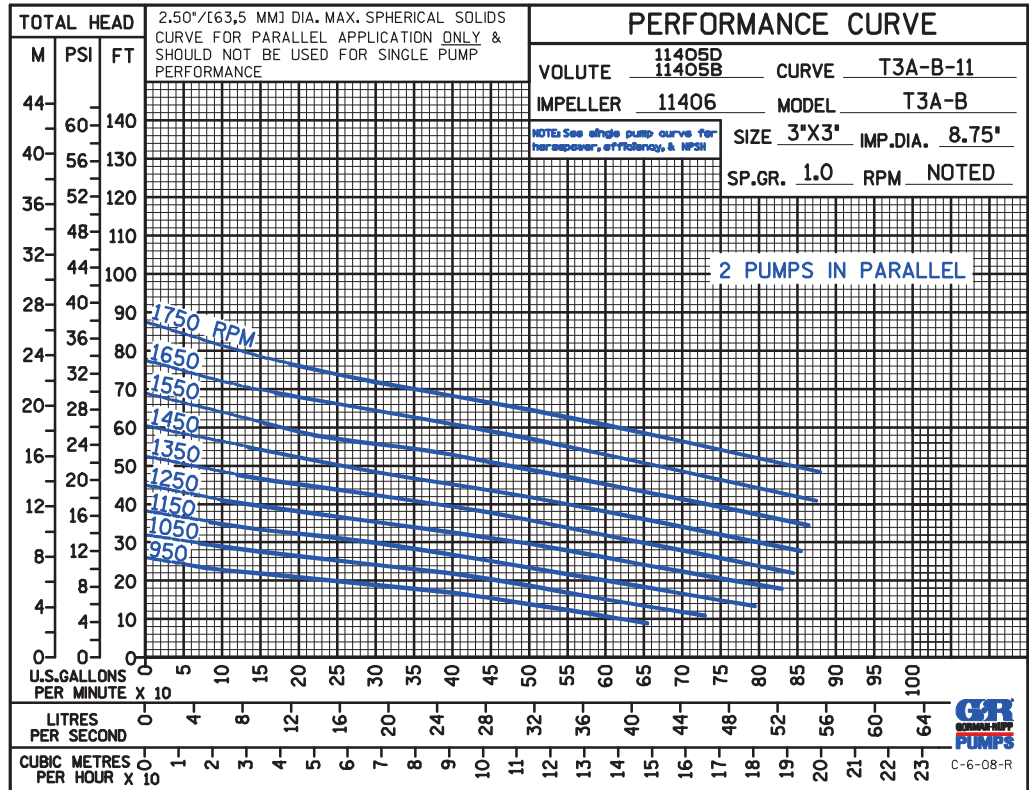
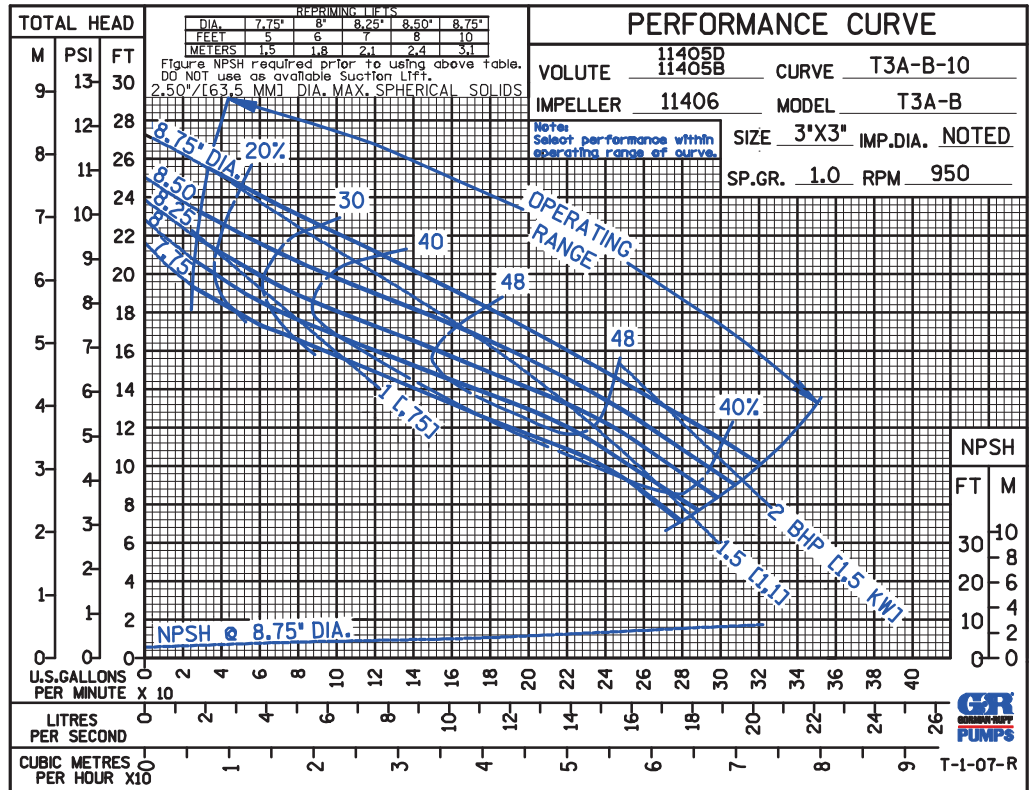

THE GORMAN-RUPP COMPANY • MANSFIELD, OHIO

GORMAN-RUPP OF CANADA LIMITED • ST. THOMAS, ONTARIO, CANADA

Specifications Subject to Change Without Notice

Printed in U.S.A.

CDS

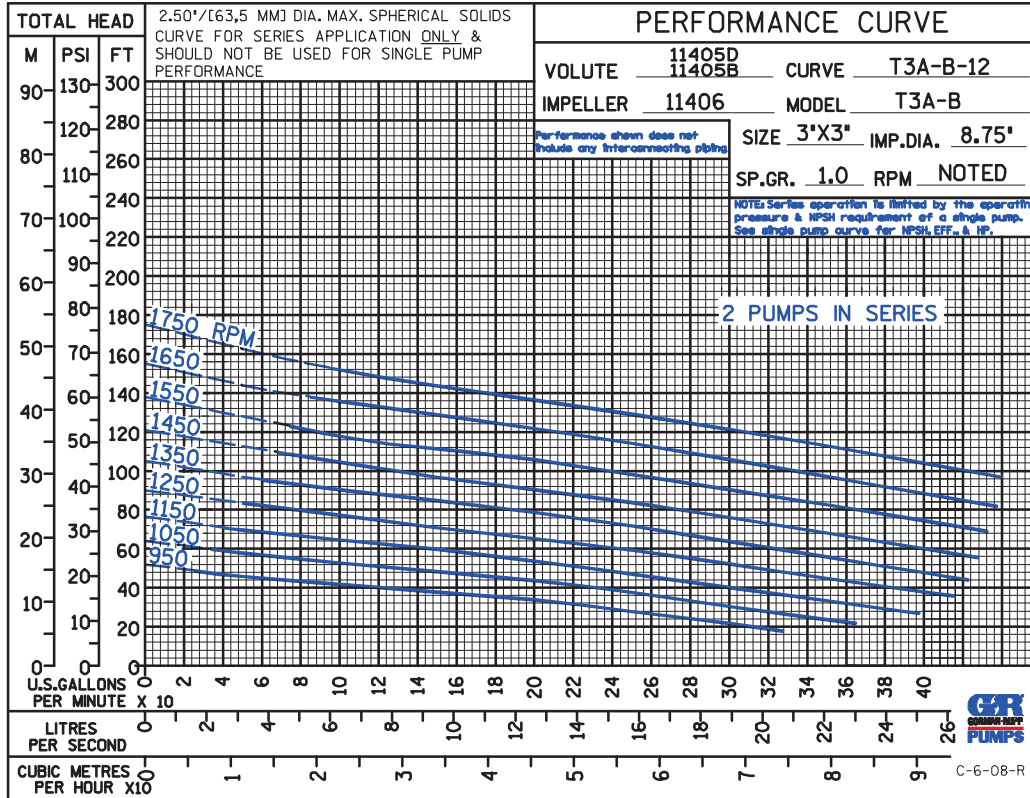

THE GORMAN-RUPP COMPANY • MANSFIELD, OHIO

GORMAN-RUPP OF CANADA LIMITED • ST. THOMAS, ONTARIO, CANADA

Specifications Subject to Change Without Notice

Printed in U.S.A.