

CDS

Self Priming Centrifugal Pump

Super
TSERIES
VARIOUS PATENTS APPLY

Model T3A71S-B

Size 3" x 3"



PUMP SPECIFICATIONS

Size: 3" x 3" (76 mm x 76 mm) NPT - Female.

Casing: Gray Iron 30.

Maximum Operating Pressure 86 psi (593 kPa).*

Semi-Open Type, Two Vane Impeller: G-R Hard Iron.

Handles 2 1/2" (63,5 mm) Diameter Spherical Solids.

Impeller Shaft: Alloy Steel 4150.

Shaft Sleeve: Alloy Steel 4130.

Replaceable Wear Plate: Hardened Alloy Steel.

Removable Adjustable Cover Plate: Gray Iron 30; 35 lbs. (16 kg)

Flap Valve: Neoprene w/Nylon and Steel Reinforcing.

Seal Plate: G-R Hard Iron.

Bearing Housing: Gray Iron 30.

Radial/Thrust Bearings: Open Single Row Ball.

Bearing and Seal Cavity Lubrication: SAE 30 Non-Detergent Oil.

Flanges: Gray Iron 30.

Gaskets: Buna-N, Compressed Synthetic Fibers, Vegetable Fiber, PTFE, Cork and Rubber.

O-Rings: Buna-N.

Hardware: Standard Plated Steel.

Brass Pressure Relief Valve.

Bearing and Seal Cavity Oil Level Sight Gauges.

Optional Equipment: Automatic Air Release Valve.

Metal Bellows Seal. 120V/240V Casing Heater. High Pump Temperature Shutdown Kit. G-R Hard Iron Casing. Self-Cleaning Wear Plate. High Chrome Cast Iron Impeller.

Gray Iron 30 Suction and Discharge Spool Flanges:

3" ASA (**Specify Model T3A71S-B /F**).

80 mm DIN 2527 (PN 16) (**Specify Model T3A71S-B /FM**).

**Consult Factory for Applications Exceeding Maximum Pressure and/or Temperature Indicated.*



Shown with Optional Suction & Discharge Spool Flanges (Available in ASA or DIN Standard Sizes).

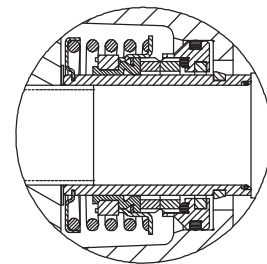
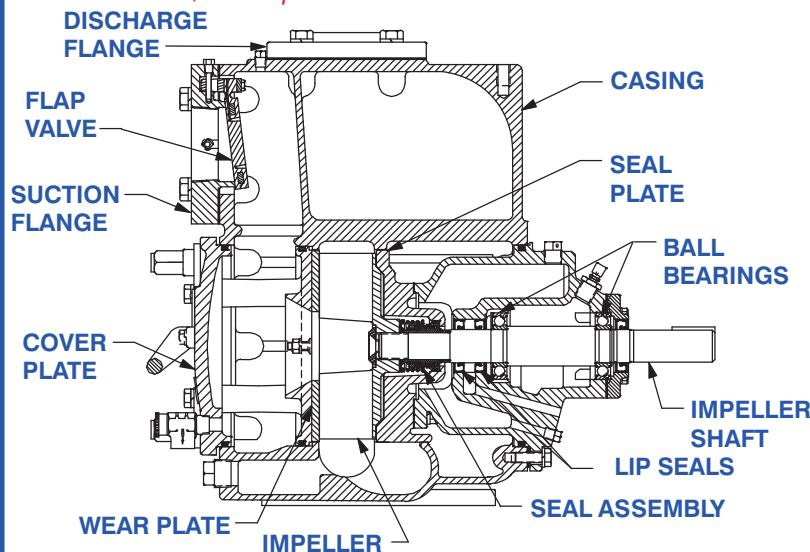

SEAL DETAIL

Cartridge Type, Mechanical, Oil-Lubricated, Double Floating, Self-Aligning. Silicon Carbide Rotating and Stationary Faces. Stainless Steel 316 Stationary Seat. Fluorocarbon Elastomers (DuPont Viton® or Equivalent). Stainless Steel 18-8 Cage and Spring. Maximum Temperature of Liquid Pumped, 160°F (71°C).*



THE GORMAN-RUPP COMPANY • MANSFIELD, OHIO

GORMAN-RUPP OF CANADA LIMITED • ST. THOMAS, ONTARIO, CANADA

www.grpumps.com

Specifications Subject to Change Without Notice

Printed in U.S.A.

Specification Data

SECTION 55, PAGE 2040

APPROXIMATE DIMENSIONS and WEIGHTS

NET WEIGHT: 414 LBS. (188 KG.)*
SHIPPING WEIGHT: 462 LBS. (210 KG.)*
EXPORT CRATE: 19.3 CU. FT. (0,55 CU. M.)
***ADD 10 LBS. (4,5 KG.) W/EACH SPOOL FLANGE**

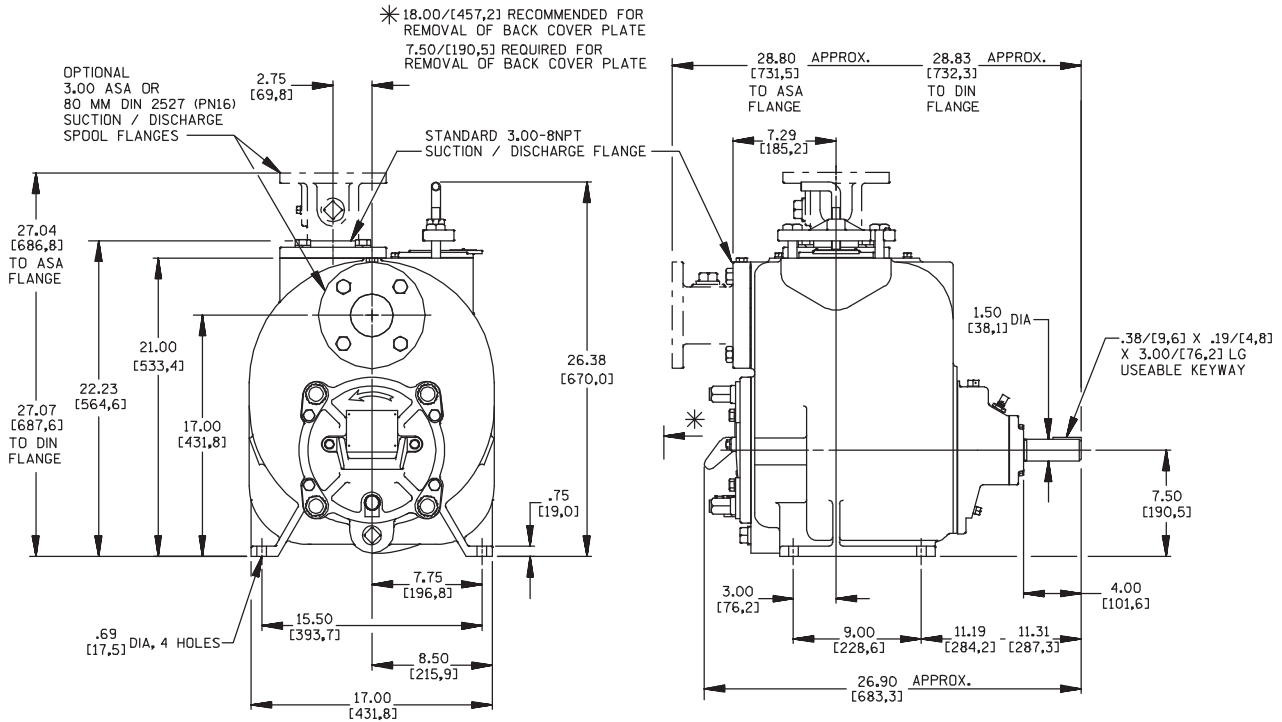

OPTIONAL ASA OR DIN STANDARD SUCTION & DISCHARGE SPOOL FLANGES AVAILABLE

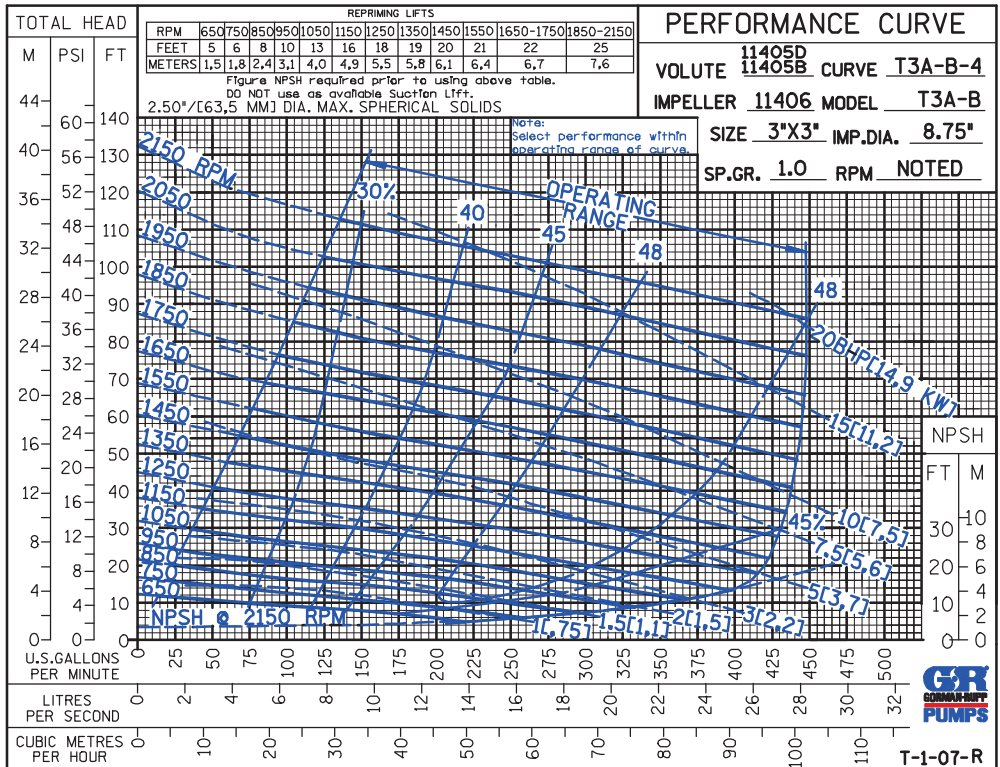

THE GORMAN-RUPP COMPANY • MANSFIELD, OHIO

GORMAN-RUPP OF CANADA LIMITED • ST. THOMAS, ONTARIO, CANADA

Specifications Subject to Change Without Notice

Printed in U.S.A.

CDS

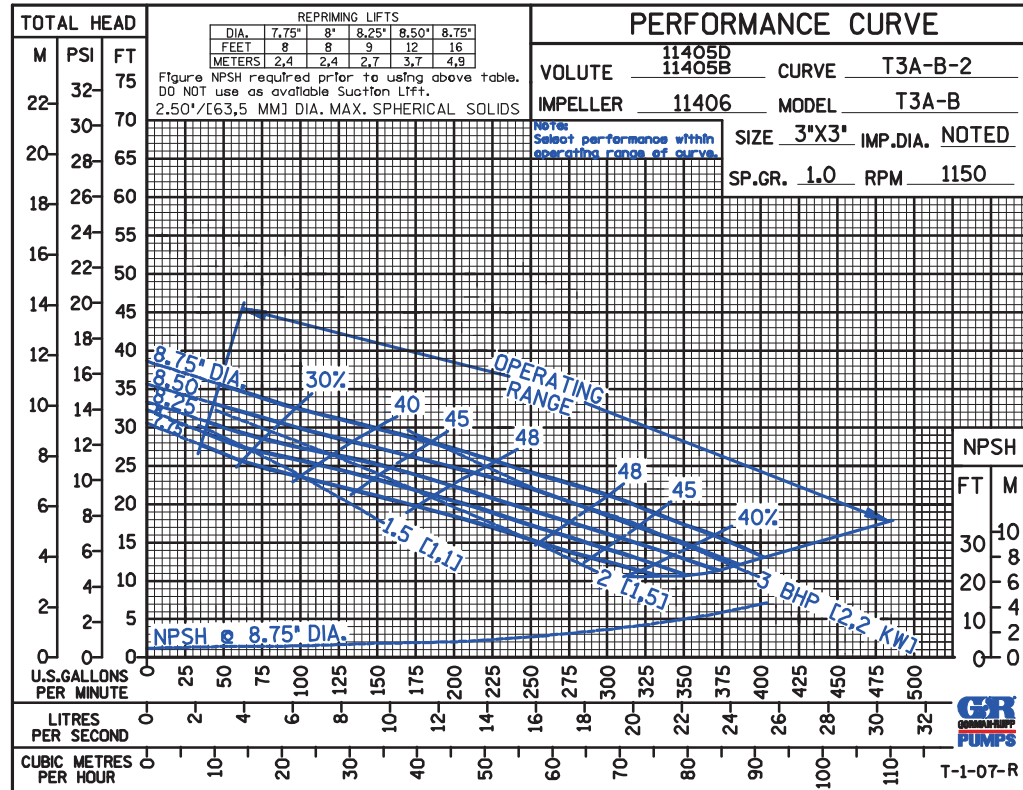
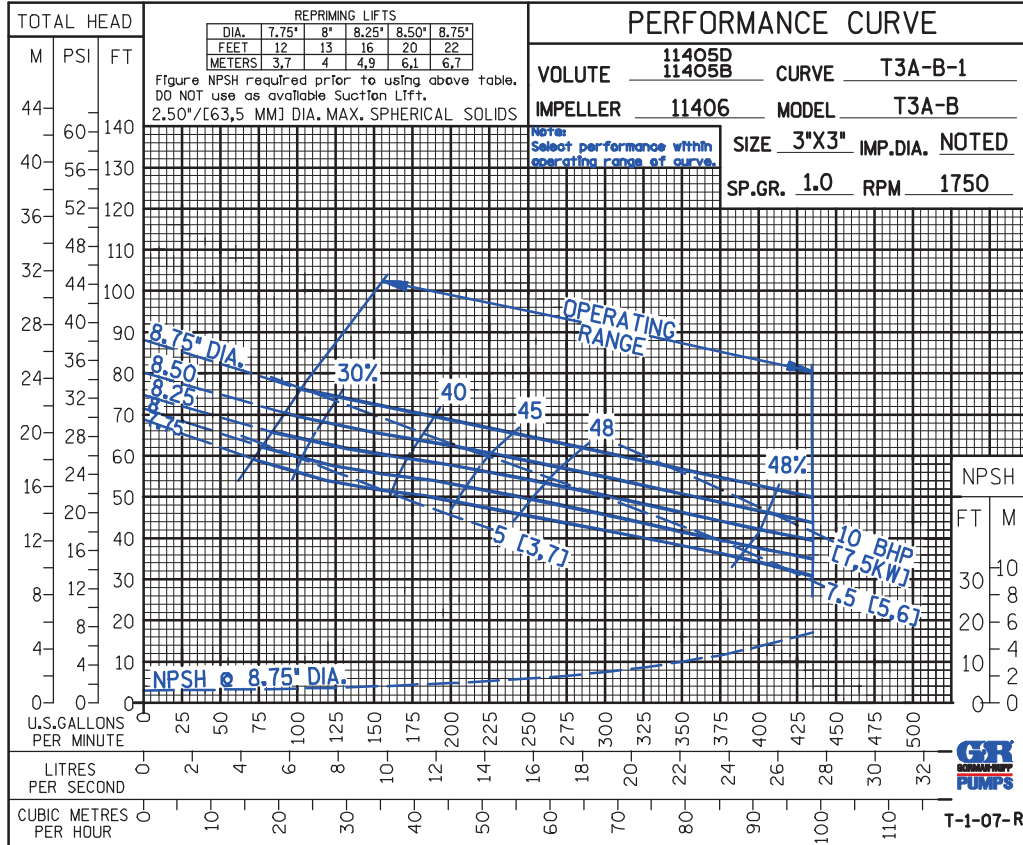

THE GORMAN-RUPP COMPANY • MANSFIELD, OHIO

GORMAN-RUPP OF CANADA LIMITED • ST. THOMAS, ONTARIO, CANADA

Specifications Subject to Change Without Notice

Printed in U.S.A.

CDS

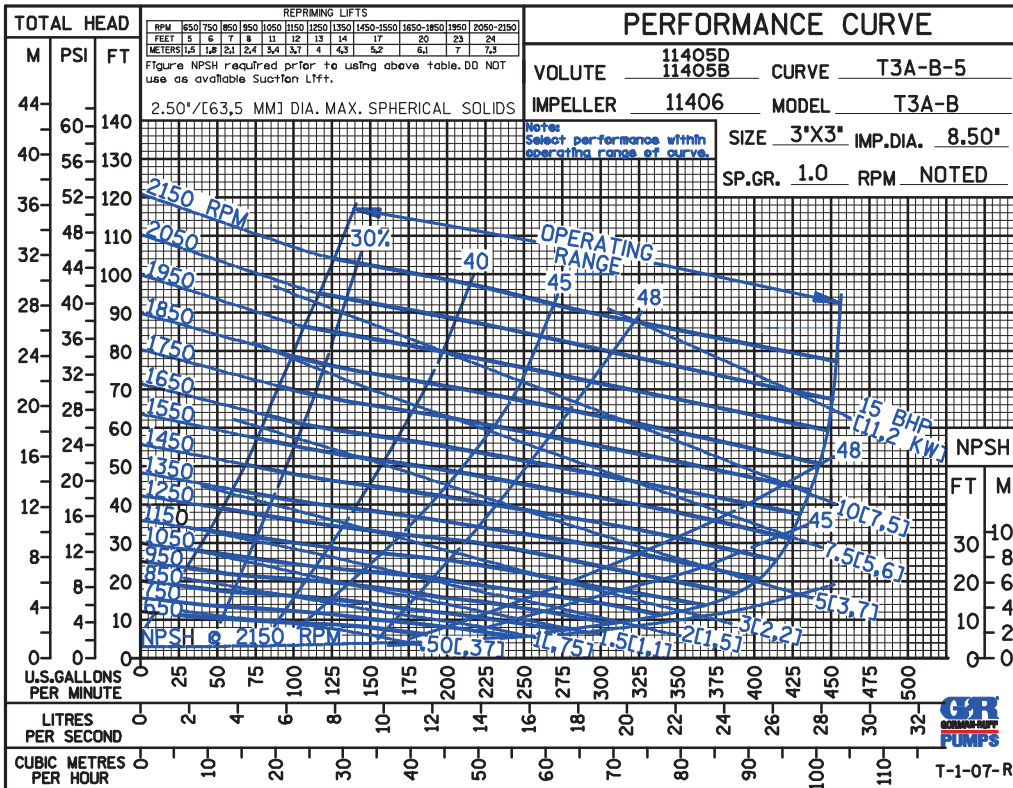
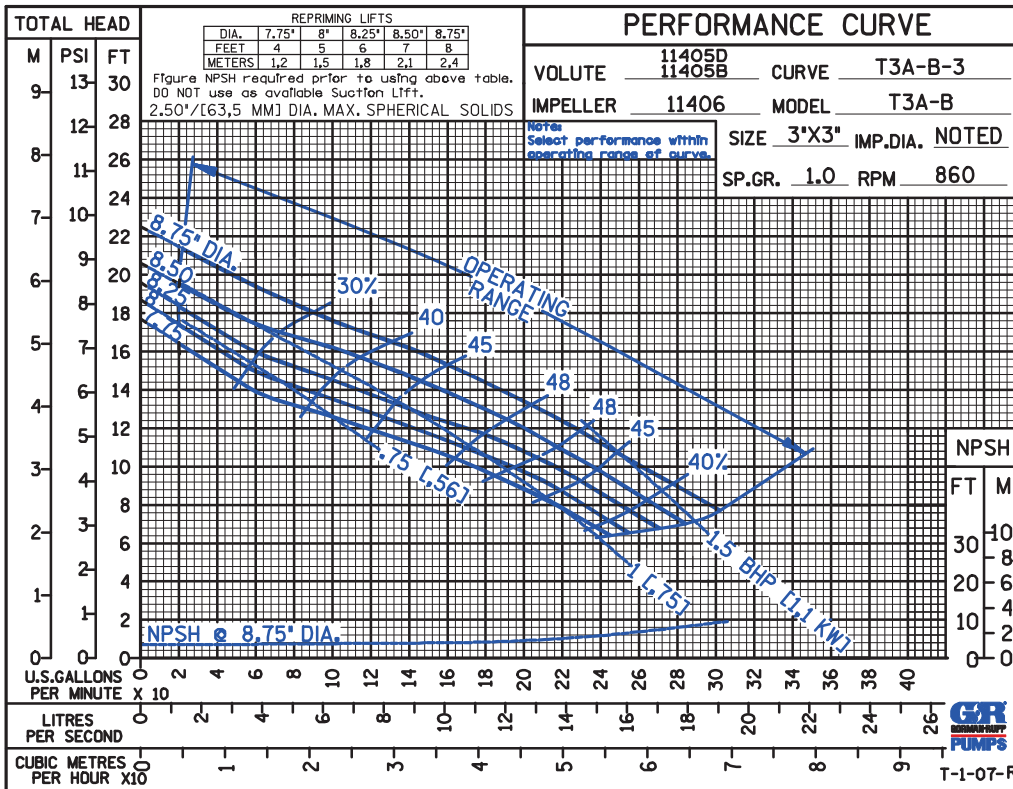

THE GORMAN-RUPP COMPANY • MANSFIELD, OHIO

GORMAN-RUPP OF CANADA LIMITED • ST. THOMAS, ONTARIO, CANADA

Specifications Subject to Change Without Notice

Printed in U.S.A.

CDS

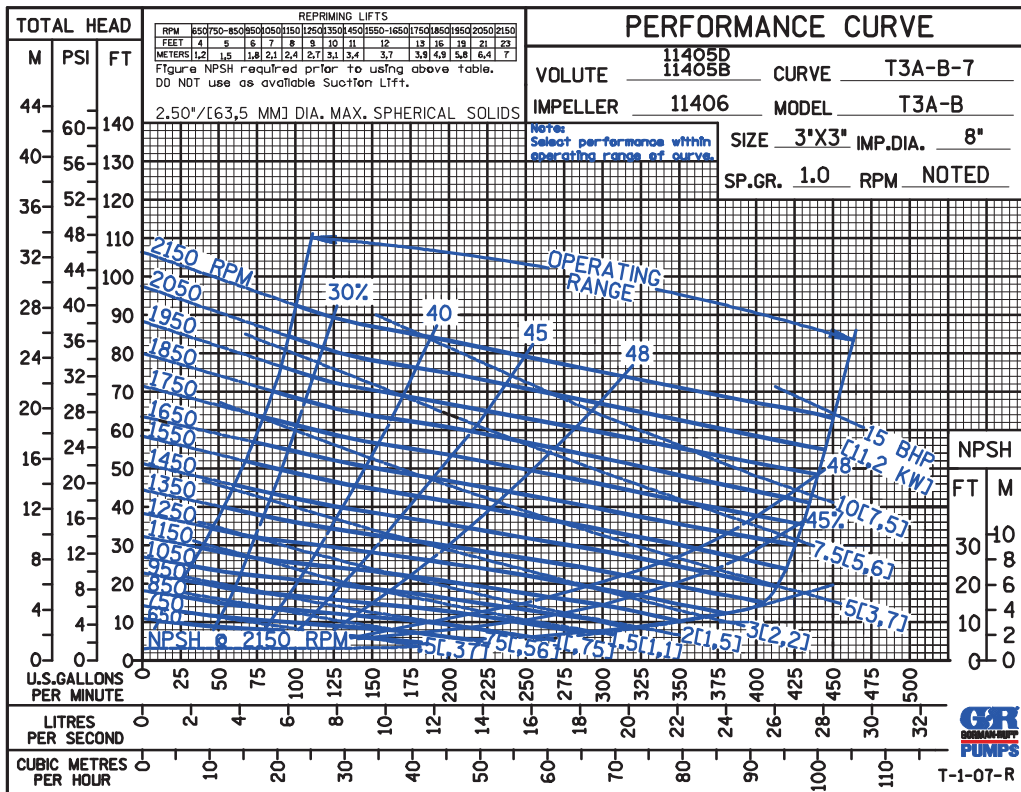
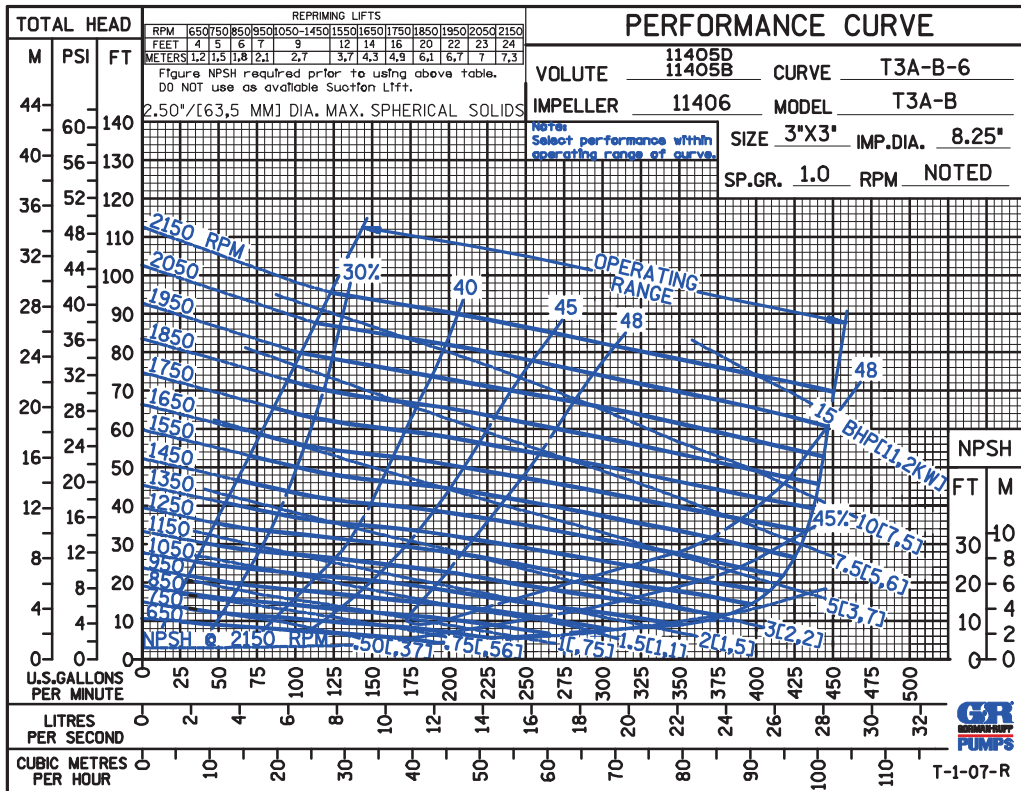

THE GORMAN-RUPP COMPANY • MANSFIELD, OHIO

GORMAN-RUPP OF CANADA LIMITED • ST. THOMAS, ONTARIO, CANADA

Specifications Subject to Change Without Notice

Printed in U.S.A.

CDS

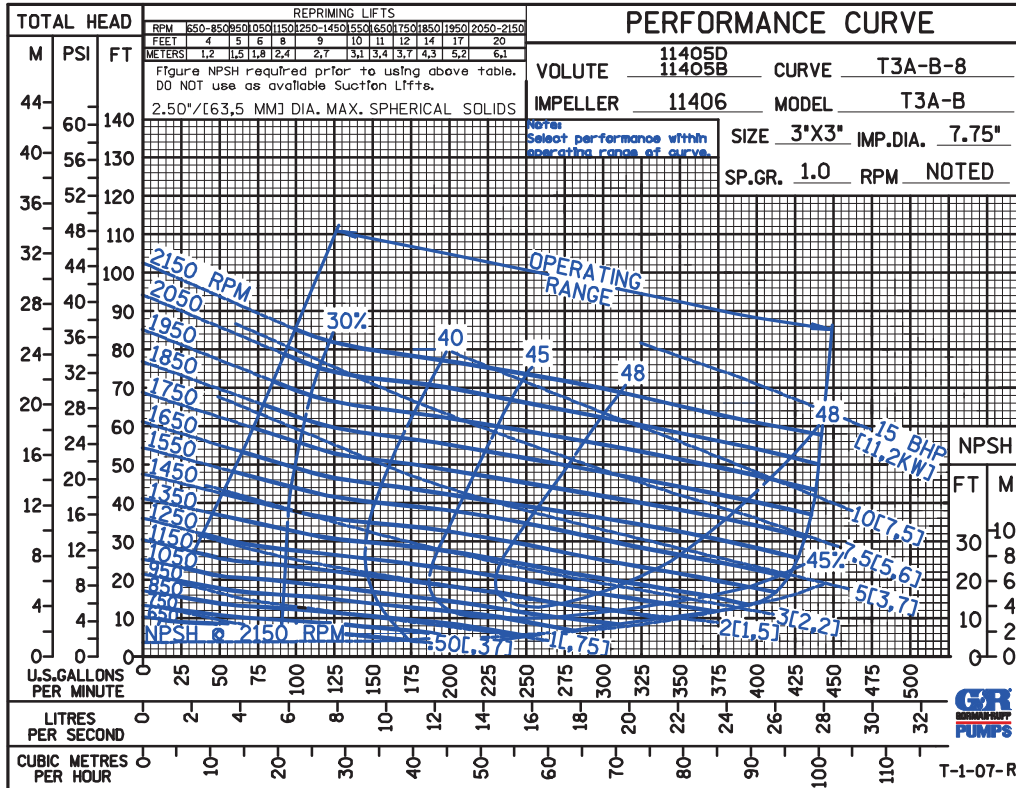

50 HERTZ

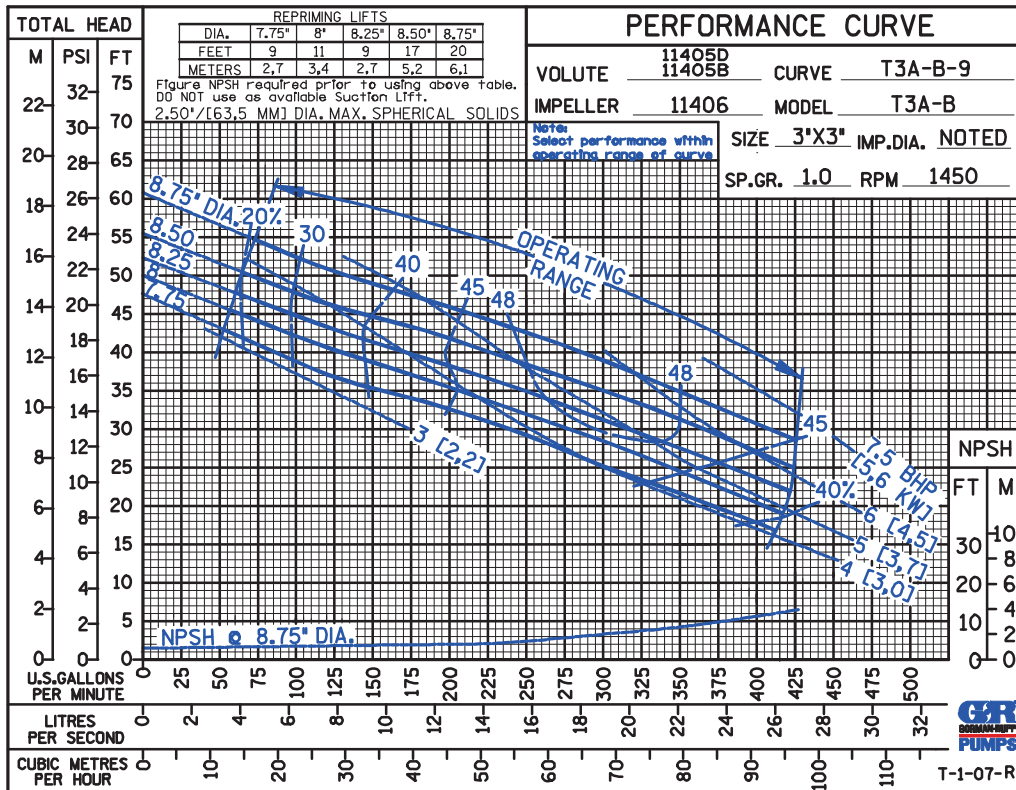

THE GORMAN-RUPP COMPANY • MANSFIELD, OHIO

GORMAN-RUPP OF CANADA LIMITED • ST. THOMAS, ONTARIO, CANADA

Specifications Subject to Change Without Notice

Printed in U.S.A.

CDS

50 HERTZ

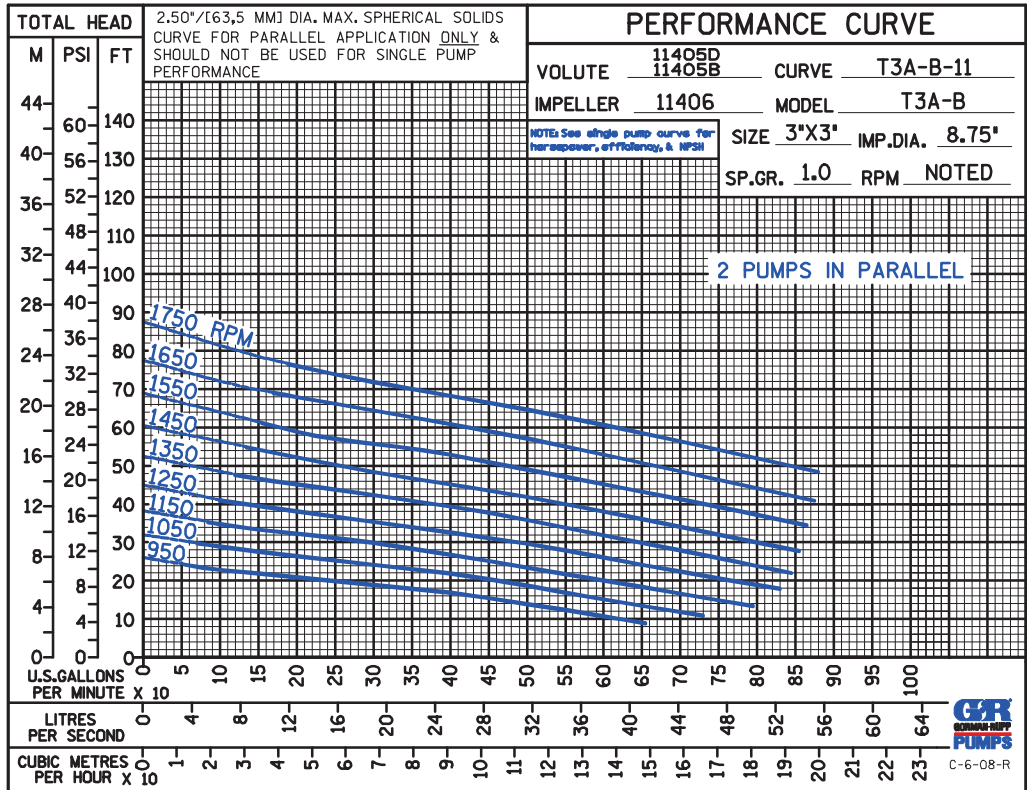
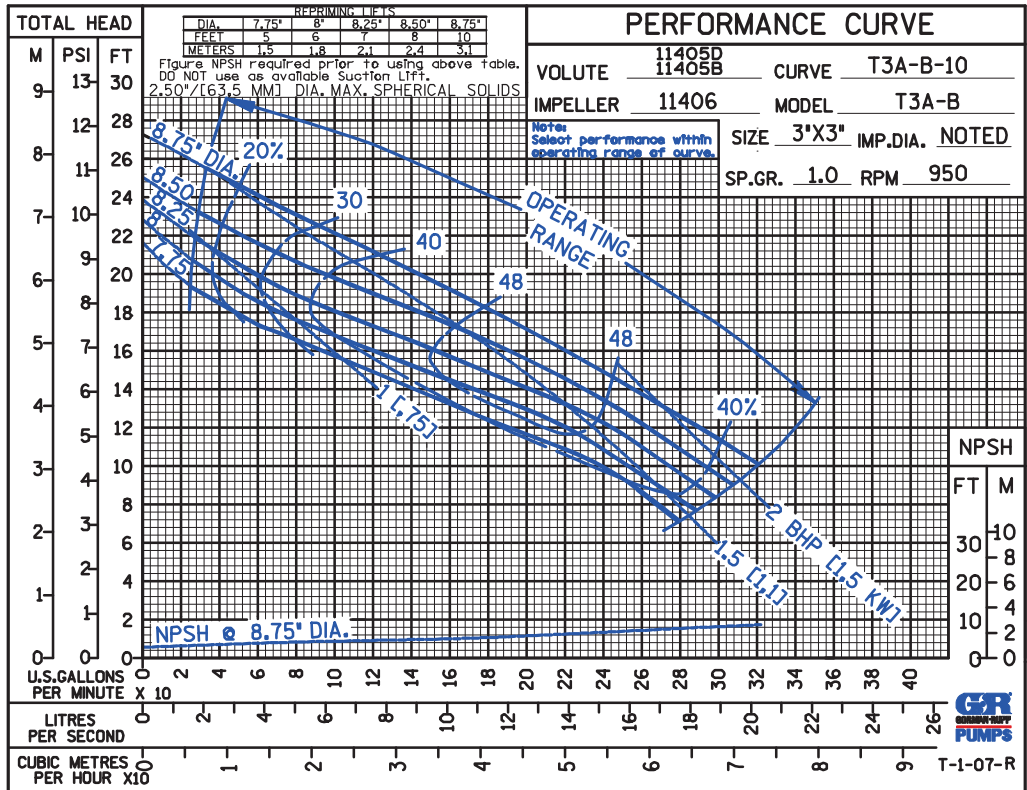

THE GORMAN-RUPP COMPANY • MANSFIELD, OHIO

GORMAN-RUPP OF CANADA LIMITED • ST. THOMAS, ONTARIO, CANADA

Specifications Subject to Change Without Notice

Printed in U.S.A.

CDS

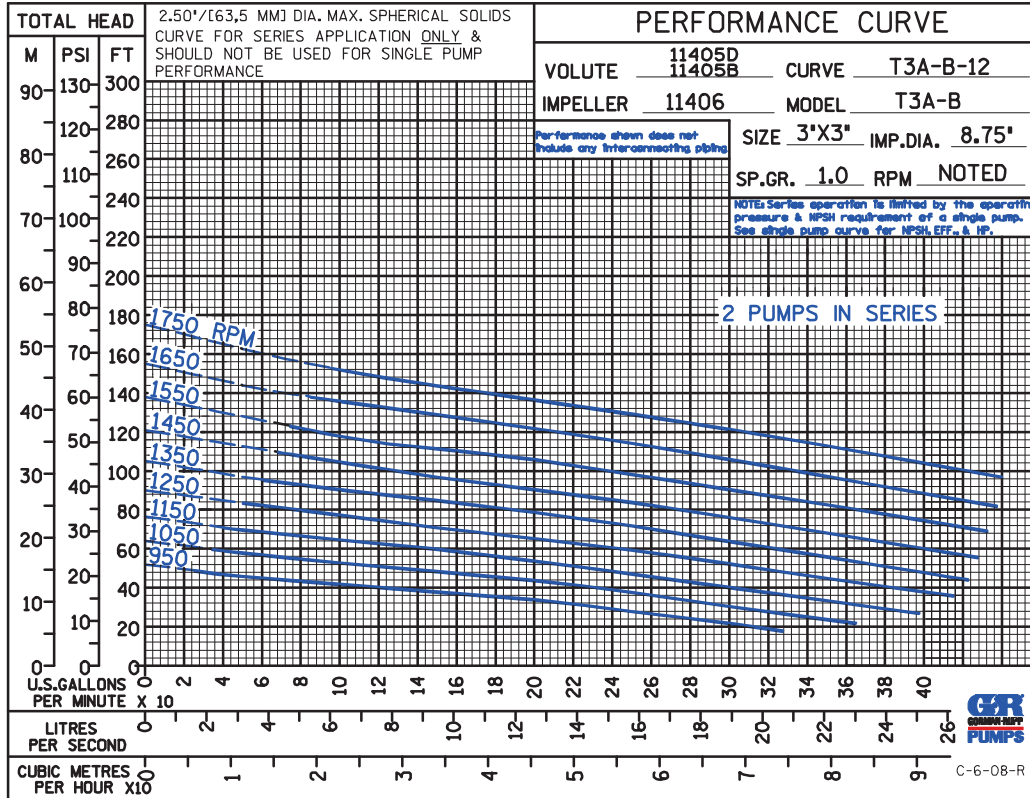

THE GORMAN-RUPP COMPANY • MANSFIELD, OHIO

GORMAN-RUPP OF CANADA LIMITED • ST. THOMAS, ONTARIO, CANADA

Specifications Subject to Change Without Notice

Printed in U.S.A.