

CDS

Self Priming Centrifugal Pump

Super
TSERIES

VARIOUS PATENTS APPLY

Model T4A61S-B

Size 4" x 4"



PUMP SPECIFICATIONS

Size: 4" x 4" (101 mm x 101 mm) NPT - Female.

Casing: Gray Iron 30.

Maximum Operating Pressure 86 psi (593 kPa).*

Semi-Open Type, Two Vane Impeller: Stainless Steel 316.

Handles 3" (76.2 mm) Diameter Spherical Solids.

Impeller Shaft: Stainless Steel 17-4 PH.

Replaceable Wear Plate: Stainless Steel 316.

Removable Adjustable Cover Plate: Gray Iron 30; 40 lbs. (18 kg).

Flap Valve: Neoprene w/Nylon and Steel Reinforcing.

Seal Plate: Stainless Steel 316.

Bearing Housing: Gray Iron 30.

Radial Bearing: Open Single Row Ball.

Thrust Bearing: Open Double Row Ball.

Bearing and Seal Cavity Lubrication: SAE 30 Non-Detergent Oil.

Flanges: Gray Iron 30.

Gaskets: Buna-N, w/Compressed Synthetic Fibers, Vegetable Fiber, PTFE, Cork, and Rubber.

O-Rings: Buna-N.

Internal Wetted Hardware: Stainless Steel 316.

External Hardware: Standard Plated Steel.

Pressure Relief Valve: Stainless Steel 316.

Bearing and Seal Cavity Oil Level Sight Gauges.

Optional Equipment: Metal Bellows Seal. Automatic Air Release Valve.

Stainless Steel CD4MCu Impeller, Seal Plate and Wear Plate.

120V/240V Casing Heater. High Pump Temperature Shutdown Kit.

Self-Cleaning Wear Plate.

Gray Iron 30 Suction and Discharge Spool Flanges:

4" ASA (**Specify Model T4A61S-B /F**).

100 mm DIN 2527 (PN 16) (**Specify Model T4A61S-B /FM**).

**Consult Factory for Applications Exceeding Maximum Pressure and/or Temperature Indicated.*



Shown with Optional Suction & Discharge Spool Flanges (Available in ASA or DIN Standard Sizes).

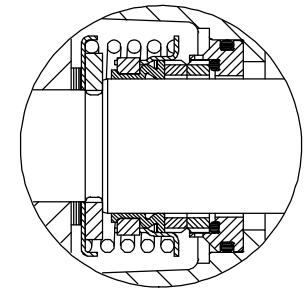
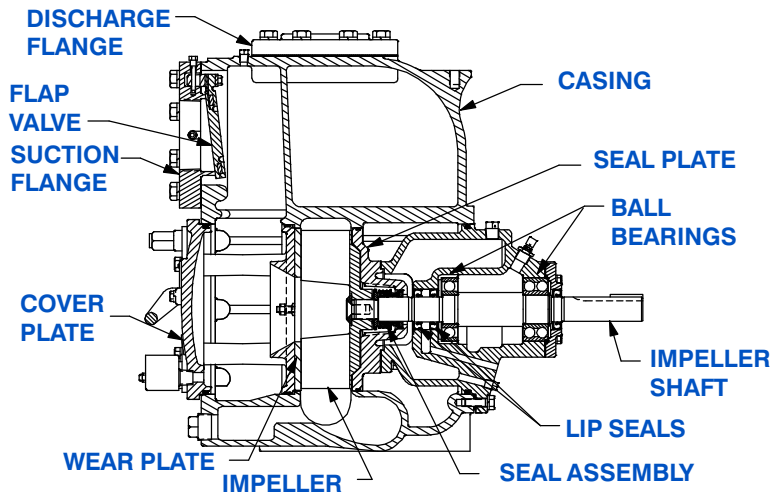

SEAL DETAIL

Mechanical, Oil-Lubricated, Double Floating, Self-Aligning. Silicon Carbide Rotating and Stationary Faces. Stainless Steel 316 Stationary Seat. Fluorocarbon Elastomers (DuPont Viton® or Equivalent). Stainless Steel 18-8 Cage and Spring. Maximum Temperature of Liquid Pumped, 160°F (71°C).*



THE GORMAN-RUPP COMPANY • MANSFIELD, OHIO

GORMAN-RUPP OF CANADA LIMITED • ST. THOMAS, ONTARIO, CANADA

www.grpumps.com

Specifications Subject to Change Without Notice

Printed in U.S.A.

Specification Data

SECTION 55, PAGE 2120

APPROXIMATE DIMENSIONS and WEIGHTS

NET WEIGHT: 586 LBS. (266 KG.)
SHIPPING WEIGHT: 625 LBS. (283 KG.)
EXPORT CRATE: 22.7 CU. FT. (0,64 CU. M.)
***ADD 15 LBS. (6,8 KG.) W/EACH SPOOL FLANGE**

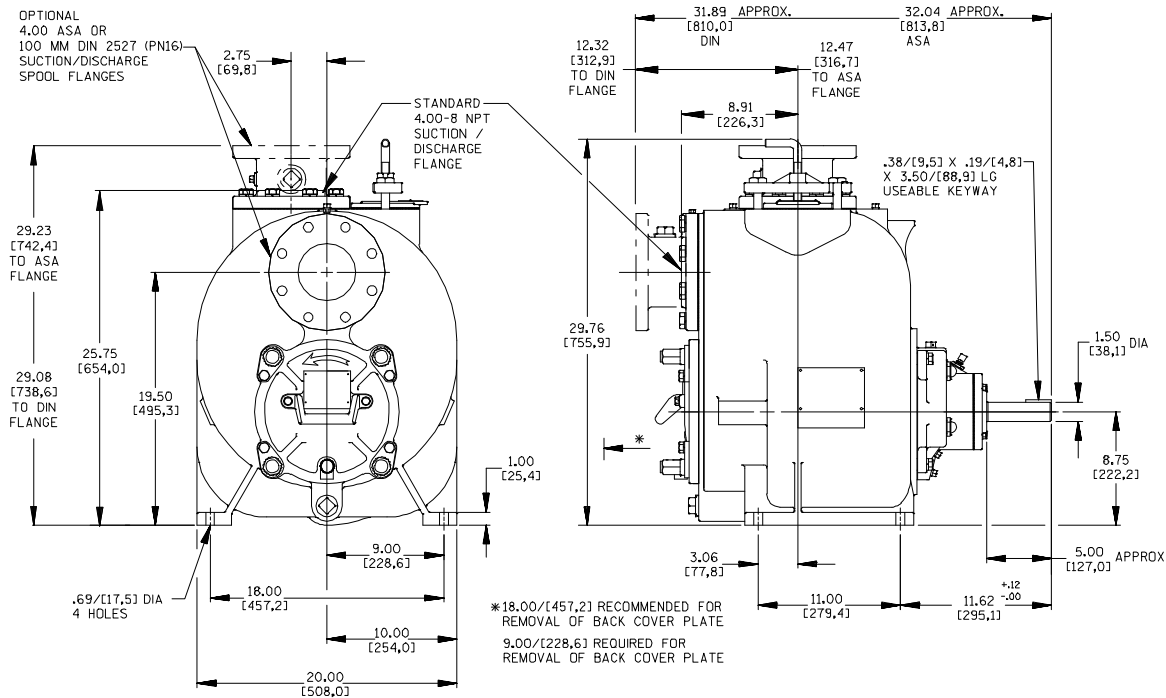

NOTE: OPTIONAL ASA OR DIN STANDARD SUCITON & DISCHARGE SPOOL FLANGES AVAILABLE.

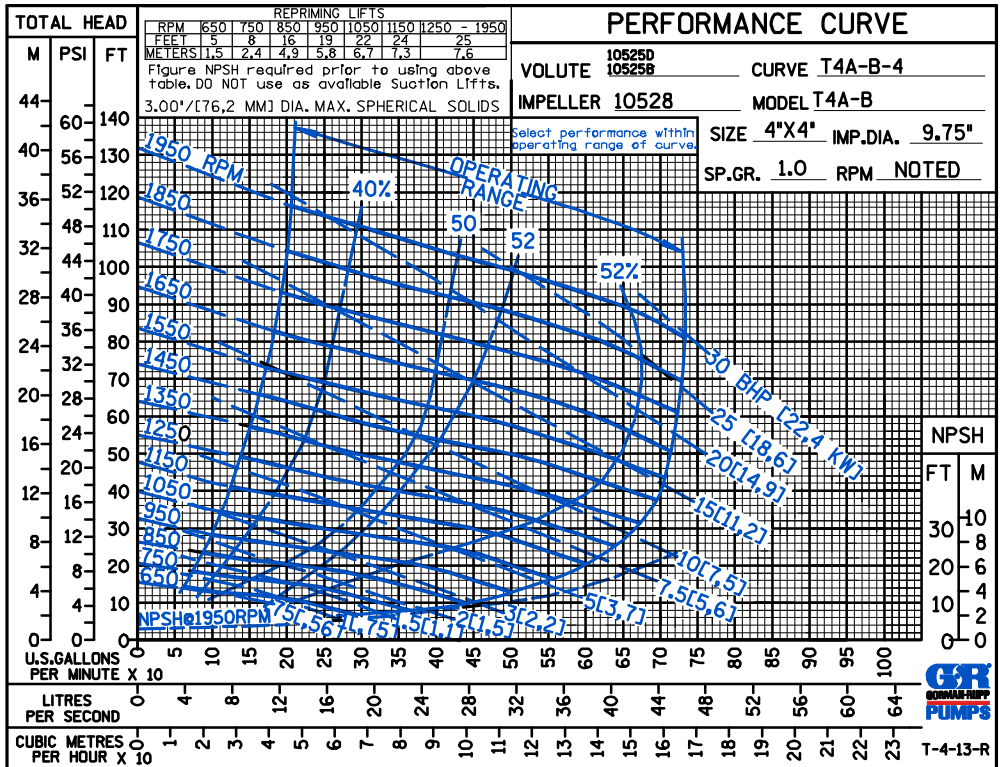

THE GORMAN-RUPP COMPANY • MANSFIELD, OHIO

GORMAN-RUPP OF CANADA LIMITED • ST. THOMAS, ONTARIO, CANADA

Specifications Subject to Change Without Notice

Printed in U.S.A.

CDS

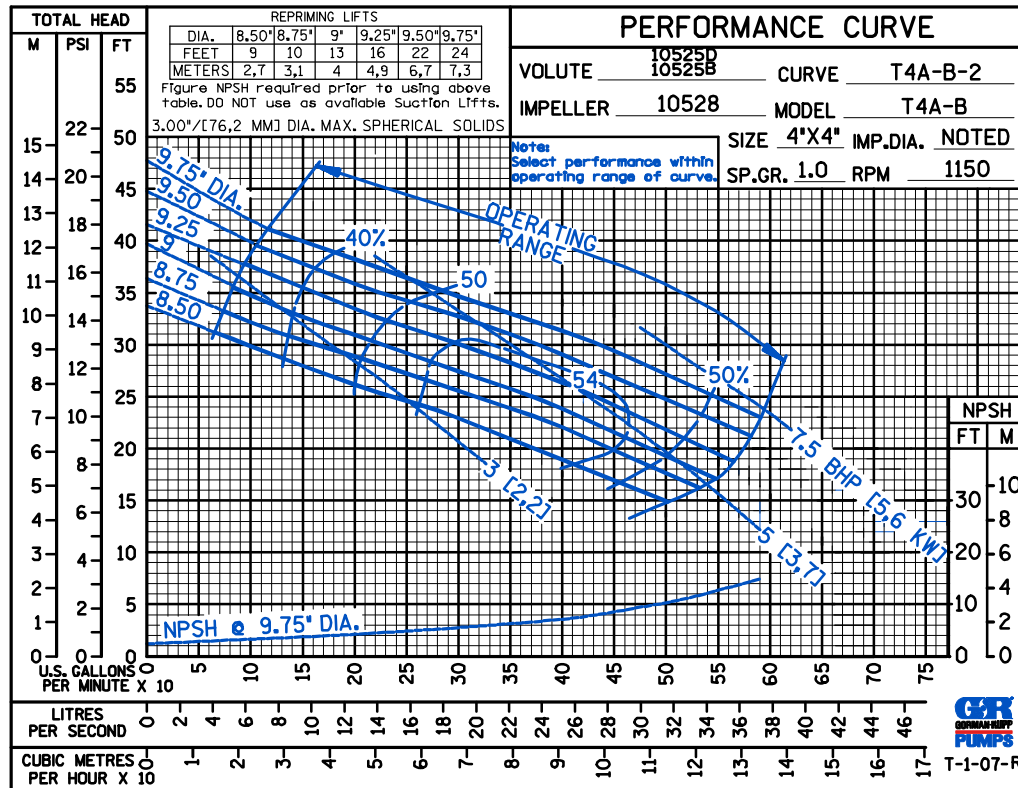
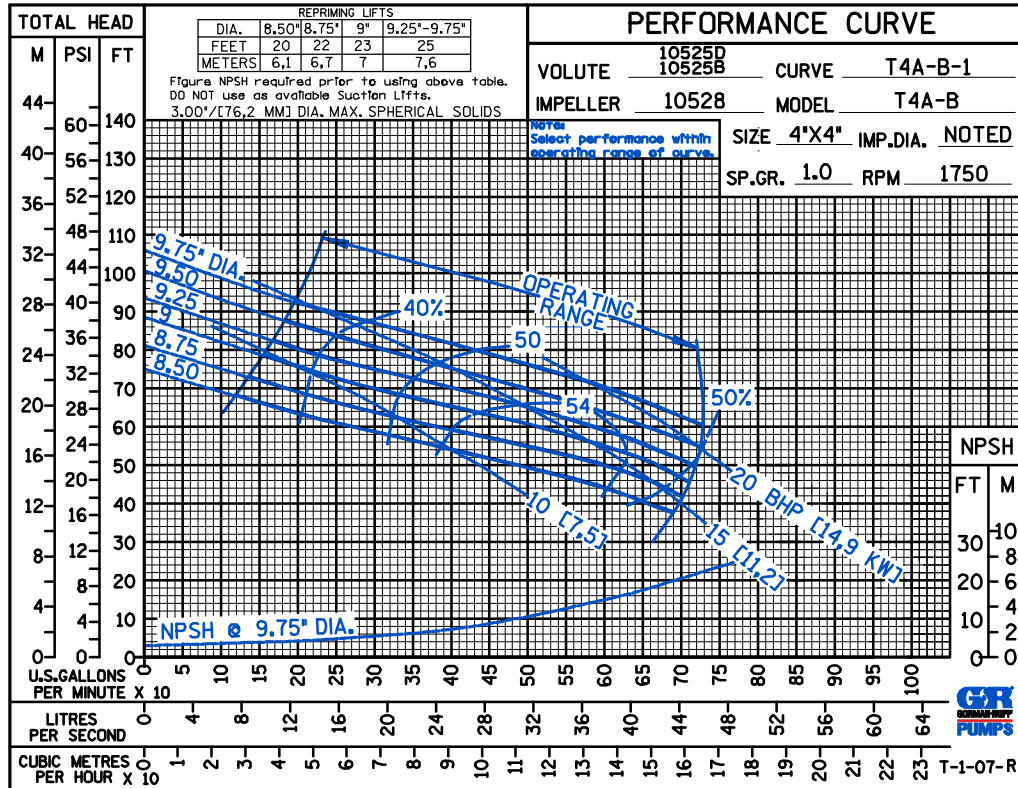

THE GORMAN-RUPP COMPANY • MANSFIELD, OHIO

GORMAN-RUPP OF CANADA LIMITED • ST. THOMAS, ONTARIO, CANADA

Specifications Subject to Change Without Notice

Printed in U.S.A.

CDS

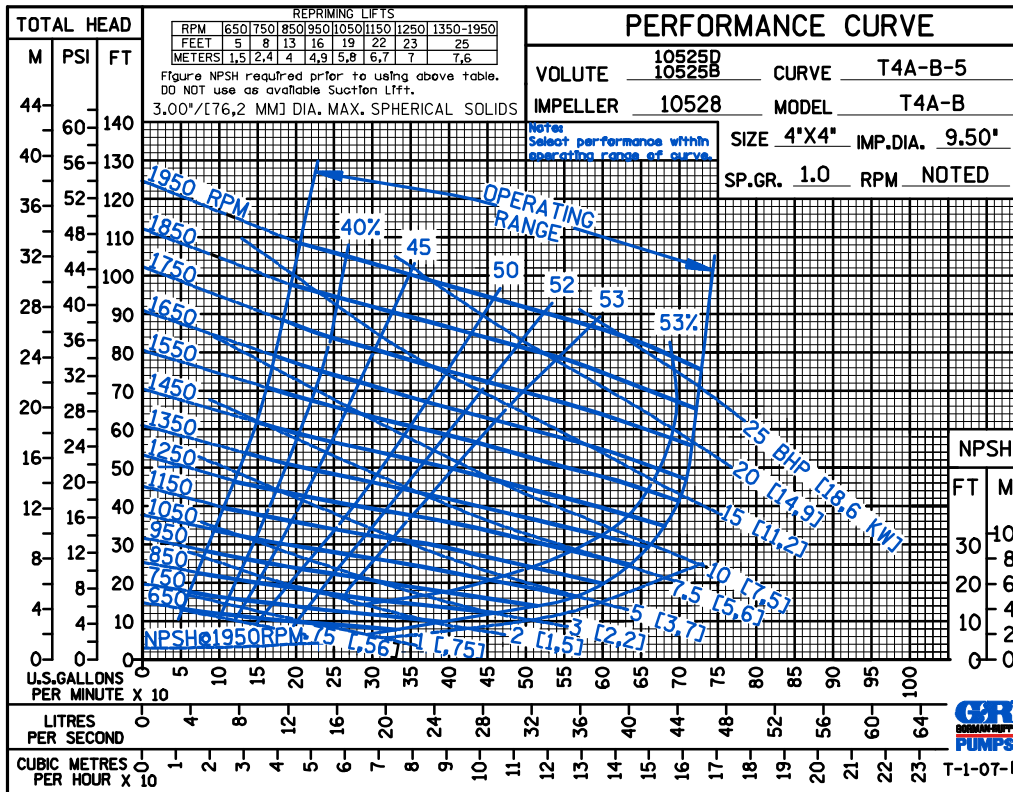
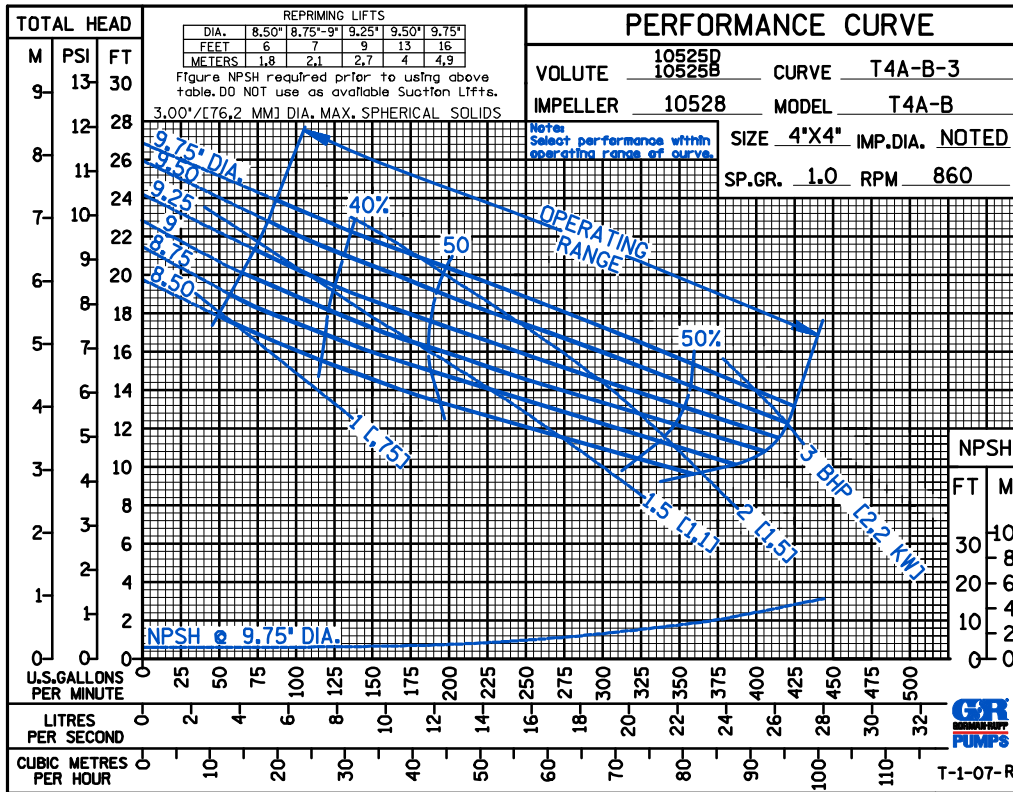

THE GORMAN-RUPP COMPANY • MANSFIELD, OHIO

GORMAN-RUPP OF CANADA LIMITED • ST. THOMAS, ONTARIO, CANADA

Specifications Subject to Change Without Notice

Printed in U.S.A.

CDS

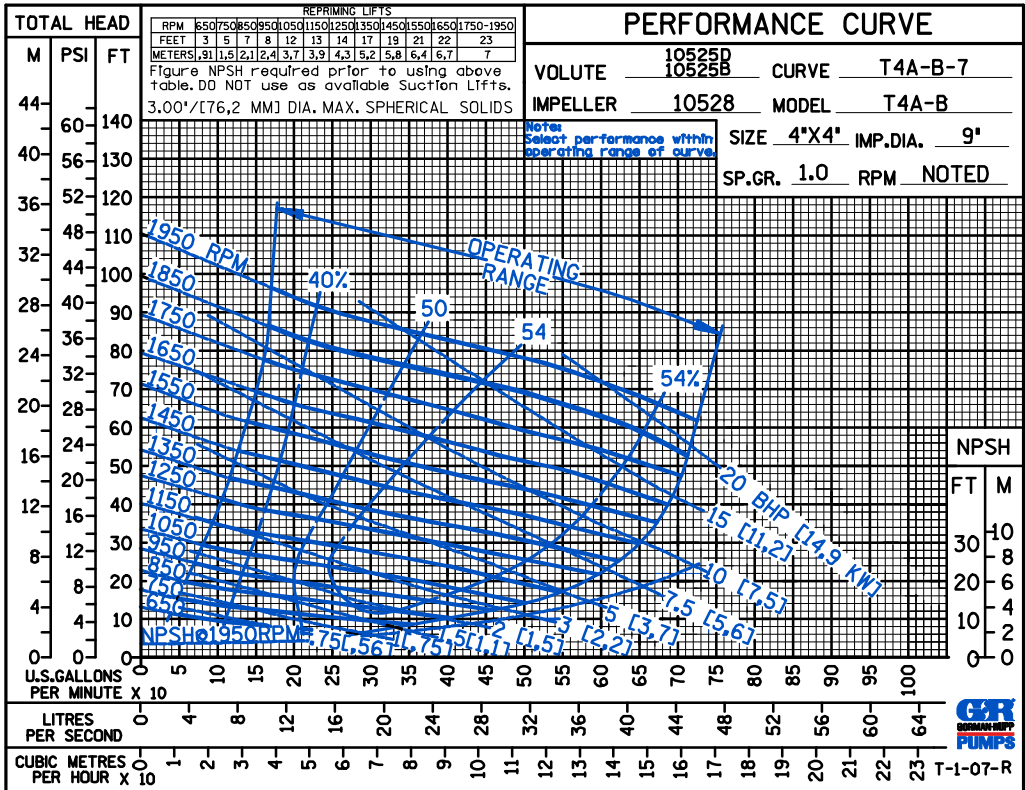
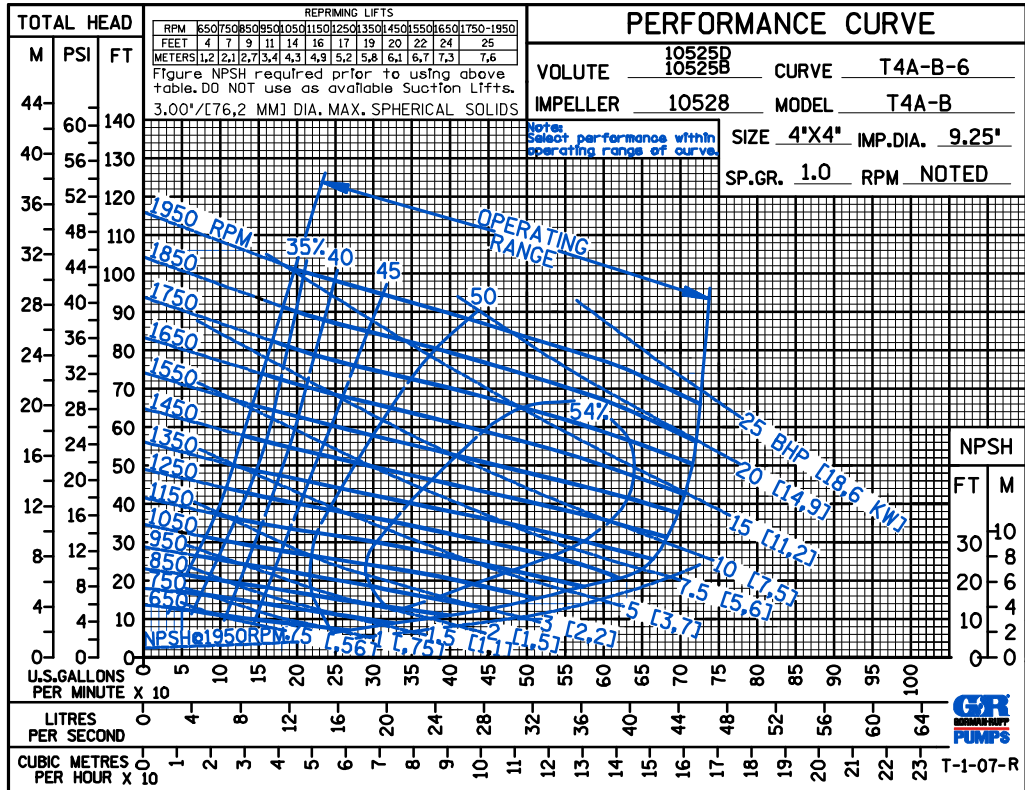

THE GORMAN-RUPP COMPANY • MANSFIELD, OHIO

GORMAN-RUPP OF CANADA LIMITED • ST. THOMAS, ONTARIO, CANADA

Specifications Subject to Change Without Notice

Printed in U.S.A.

CDS

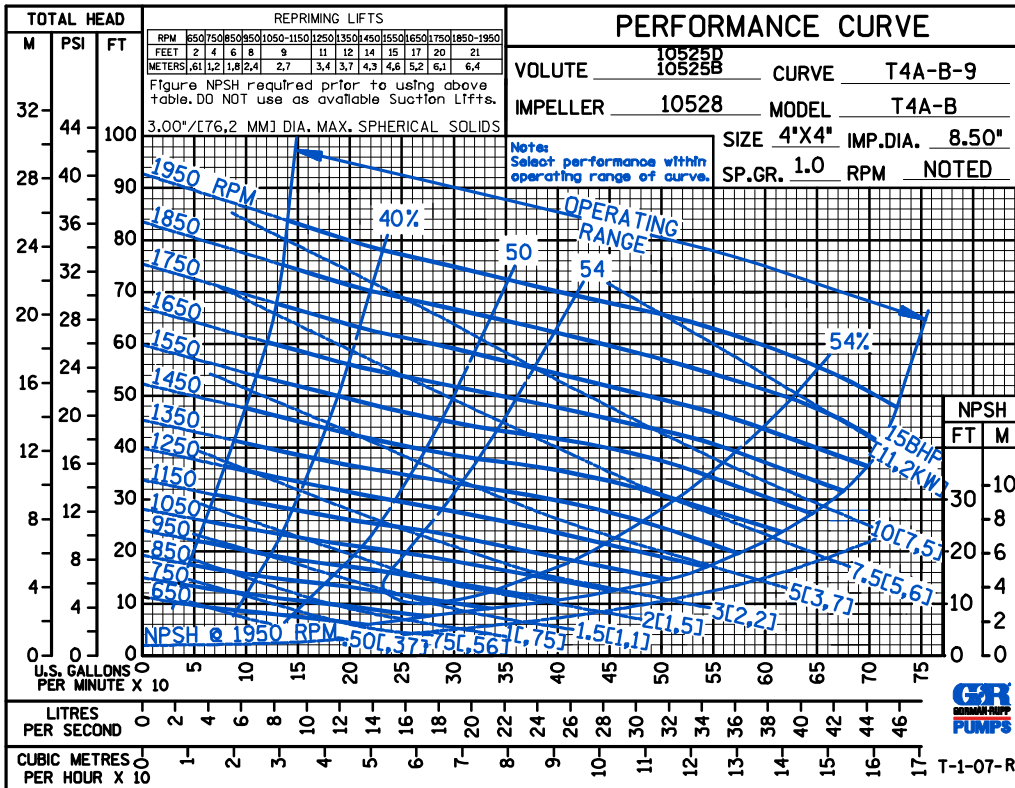
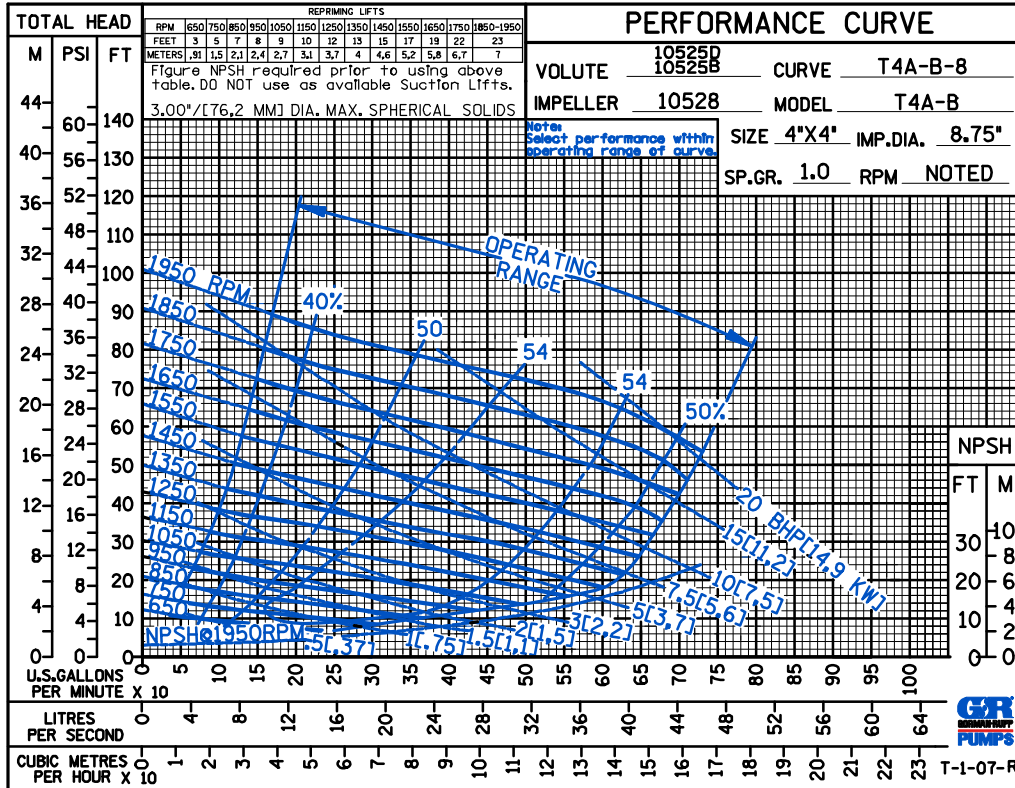

THE GORMAN-RUPP COMPANY • MANSFIELD, OHIO

GORMAN-RUPP OF CANADA LIMITED • ST. THOMAS, ONTARIO, CANADA

Specifications Subject to Change Without Notice

Printed in U.S.A.

CDS

50 HERTZ

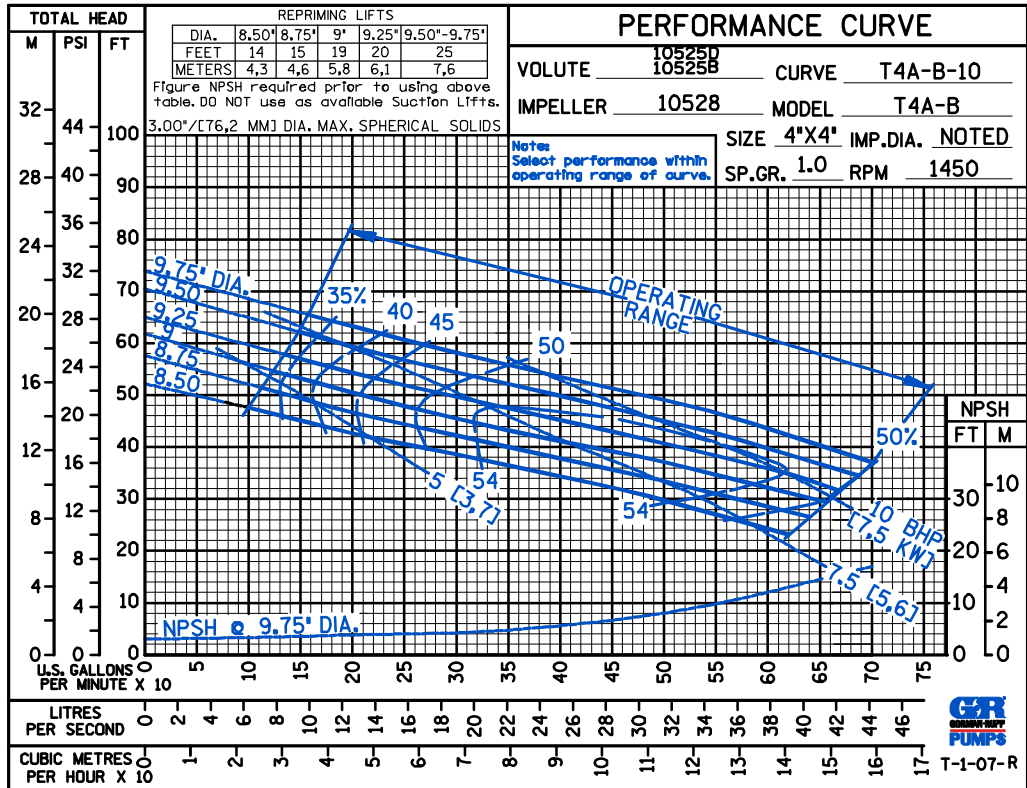

50 HERTZ

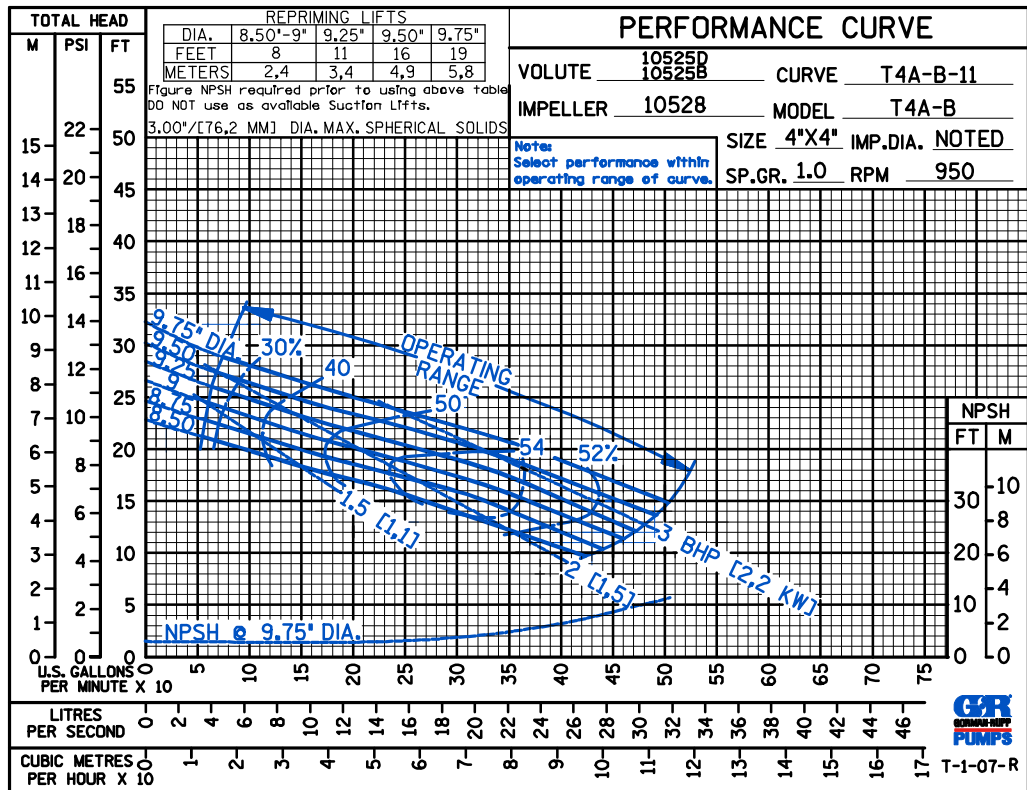

THE GORMAN-RUPP COMPANY • MANSFIELD, OHIO

GORMAN-RUPP OF CANADA LIMITED • ST. THOMAS, ONTARIO, CANADA

Specifications Subject to Change Without Notice

Printed in U.S.A.

D S

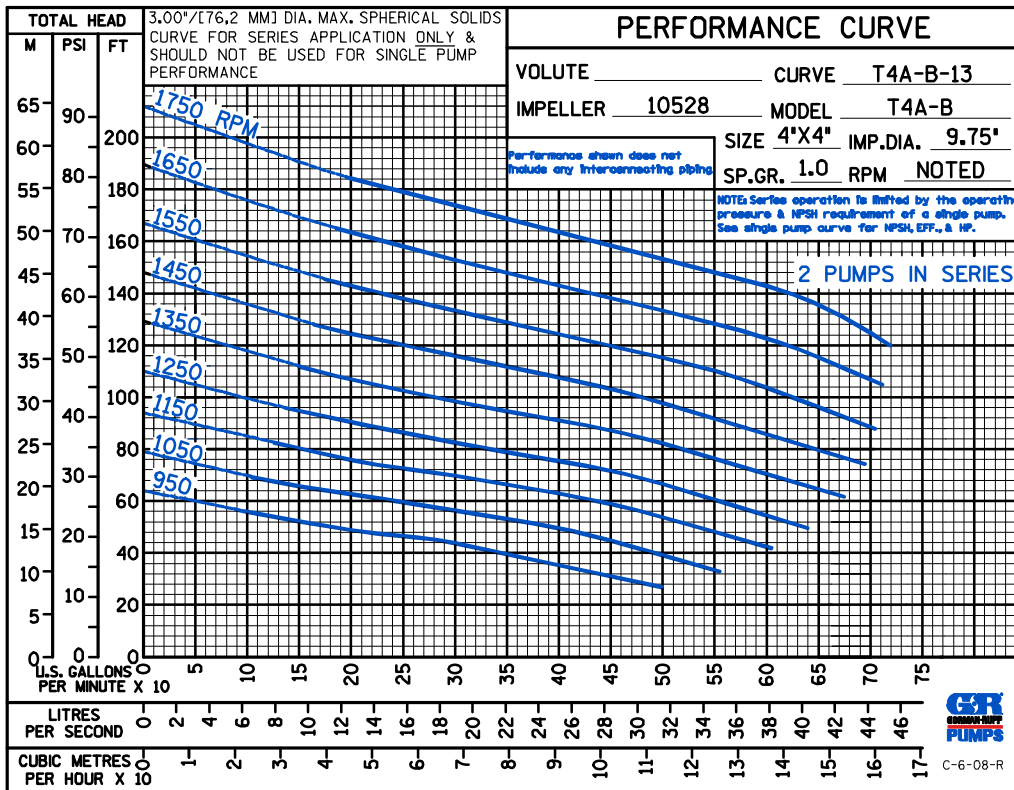
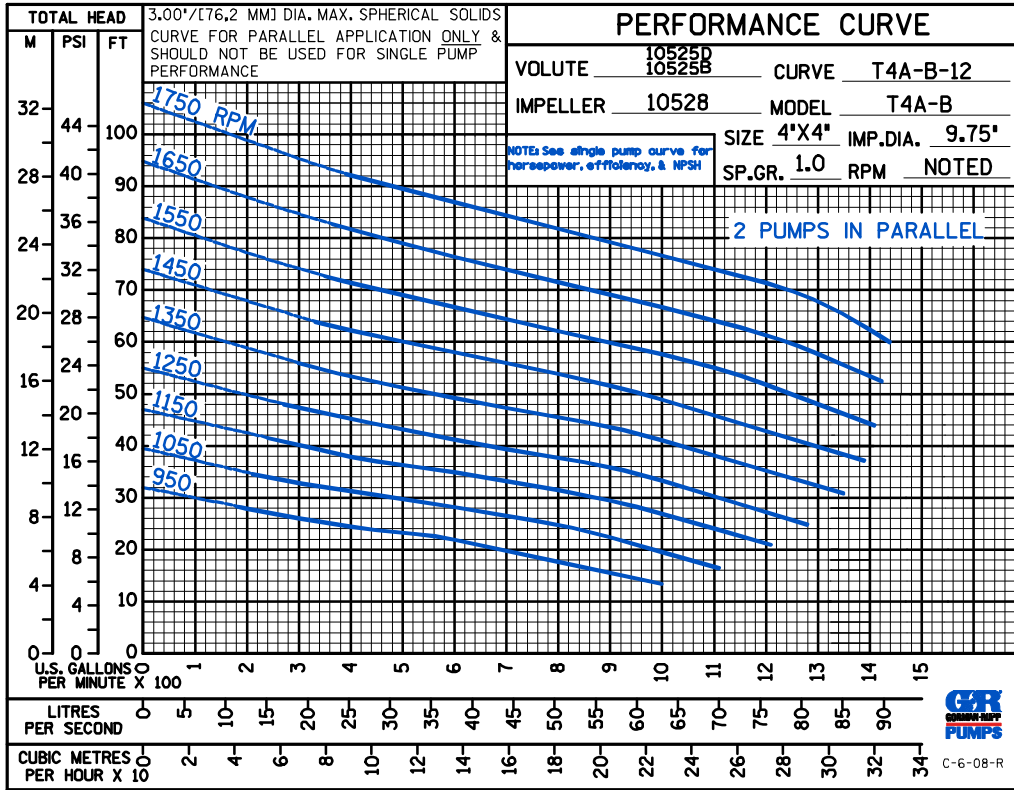

THE GORMAN-RUPP COMPANY • MANSFIELD, OHIO

GORMAN-RUPP OF CANADA LIMITED • ST. THOMAS, ONTARIO, CANADA

Specifications Subject to Change Without Notice

Printed in U.S.A.