

CDS

Self Priming Centrifugal Pump

**Super
T SERIES**

VARIOUS PATENTS APPLY

Model T4A65S-B**Size 4" x 4"****PUMP SPECIFICATIONS****Size:** 4" x 4" (101 mm x 101 mm) NPT - Female.**Casing:** Stainless Steel CD4MCu.

Maximum Operating Pressure 86 psi (593 kPa).*

Semi-Open Type, Two Vane Impeller: Stainless Steel CD4MCu.

Handles 3" (76,2 mm) Diameter Spherical Solids.

Impeller Shaft: Stainless Steel 17-4 PH.**Replaceable Wear Plate:** Stainless Steel CD4MCu.**Removable Adjustable Cover Plate:** Stainless Steel CD4MCu;

40 lbs. (18 kg).

Flap Valve: Fluorocarbon (DuPont Viton® or Equivalent) w/Stainless Steel Reinforcing.**Seal Plate:** Stainless Steel CD4MCu.**Bearing Housing:** Stainless Steel CD4MCu.**Radial Bearing:** Open Single Row Ball.**Thrust Bearing:** Open Double Row Ball.**Bearing and Seal Cavity Lubrication:** SAE 30 Non-Detergent Oil.**Suction Flange:** Stainless Steel CD4MCu.**Discharge Flange:** Stainless Steel 316.**Gaskets:** Fluorocarbon (DuPont Viton® or Equivalent) and PTFE.**O-Rings:** Fluorocarbon (DuPont Viton® or Equivalent).**Hardware:** Stainless Steel 316.**Pressure Relief Valve:** Stainless Steel 316.**Bearing and Seal Cavity Oil Level Sight Gauges.****Optional Equipment:** Metal Bellows Seal. Automatic Air

Release Valve. 120V/240V Casing Heater. High Pump

Temperature Shutdown Kit. Self-Cleaning Wear Plate.

Stainless Steel CD4MCu Suction and Discharge Spool Flanges:

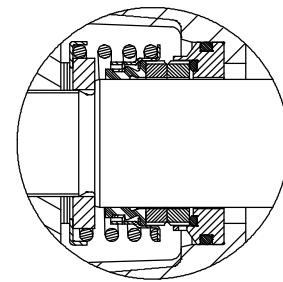
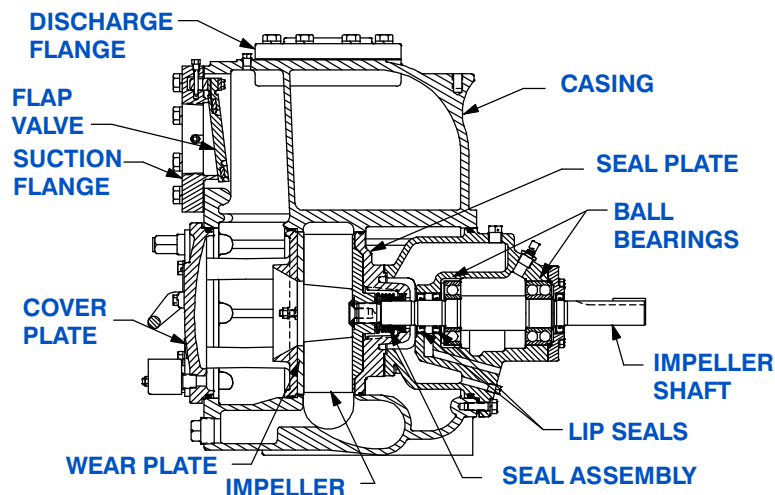
4" ASA (**Specify Model T4A65S-B /F**).100 mm DIN 2527 (PN 16) (**Specify Model T4A65S-B /FM**).***Consult Factory for Applications Exceeding
Maximum Pressure and/or Temperature Indicated.****Shown with Optional Suction & Discharge Spool Flanges (Available in ASA or DIN Standard Sizes).****SEAL DETAIL**

Mechanical, Oil-Lubricated, Double Floating, Self-Aligning. Silicon Carbide Rotating and Stationary Faces. Stainless Steel 316 Stationary Seat. Fluorocarbon Elastomers (DuPont Viton® or Equivalent). Stainless Steel 316 Cage and Spring. Maximum Temperature of Liquid Pumped, 160°F (71°C).*

**THE GORMAN-RUPP COMPANY • MANSFIELD, OHIO**

GORMAN-RUPP OF CANADA LIMITED • ST. THOMAS, ONTARIO, CANADA

www.grpumps.com

Specifications Subject to Change Without Notice

Printed in U.S.A.

Specification Data

SECTION 55, PAGE 2130

APPROXIMATE DIMENSIONS and WEIGHTS

NET WEIGHT: 595 LBS. (270 KG.)*
SHIPPING WEIGHT: 634 LBS. (288 KG.)*
EXPORT CRATE: 22.7 CU. FT. (0,64 CU. M.)
***ADD 20 LBS. (9 KG.) W/EACH SPOOL FLANGE**

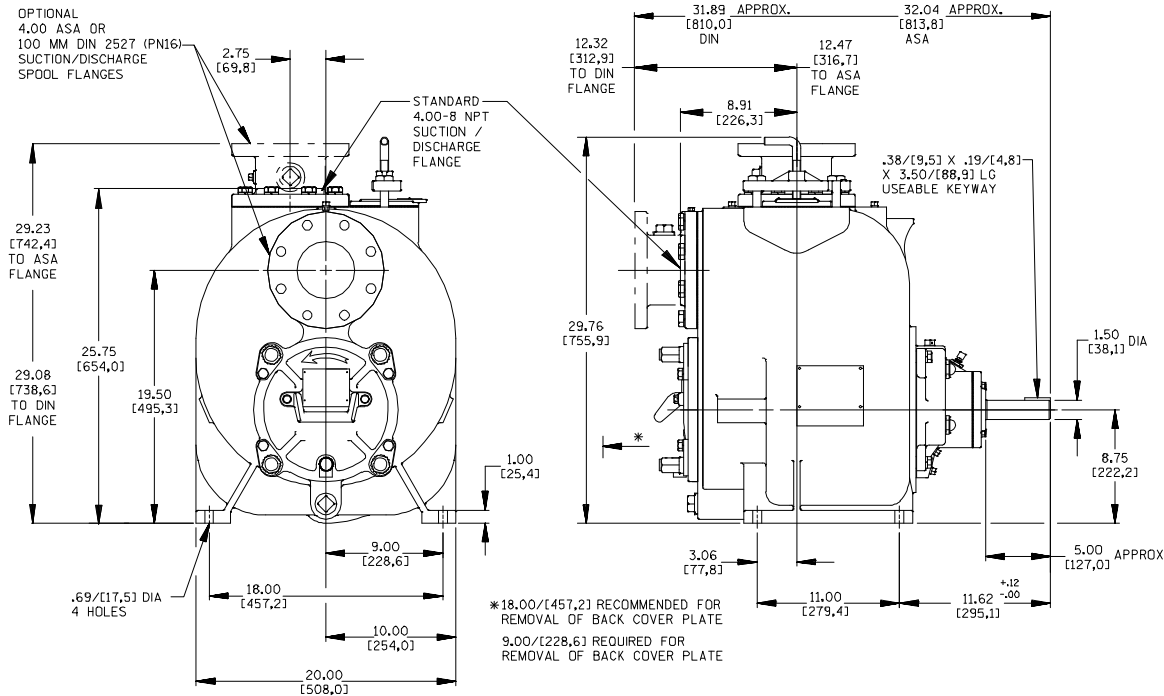

NOTE: OPTIONAL ASA OR DIN STANDARD SUCITON & DISCHARGE SPOOL FLANGES AVAILABLE.

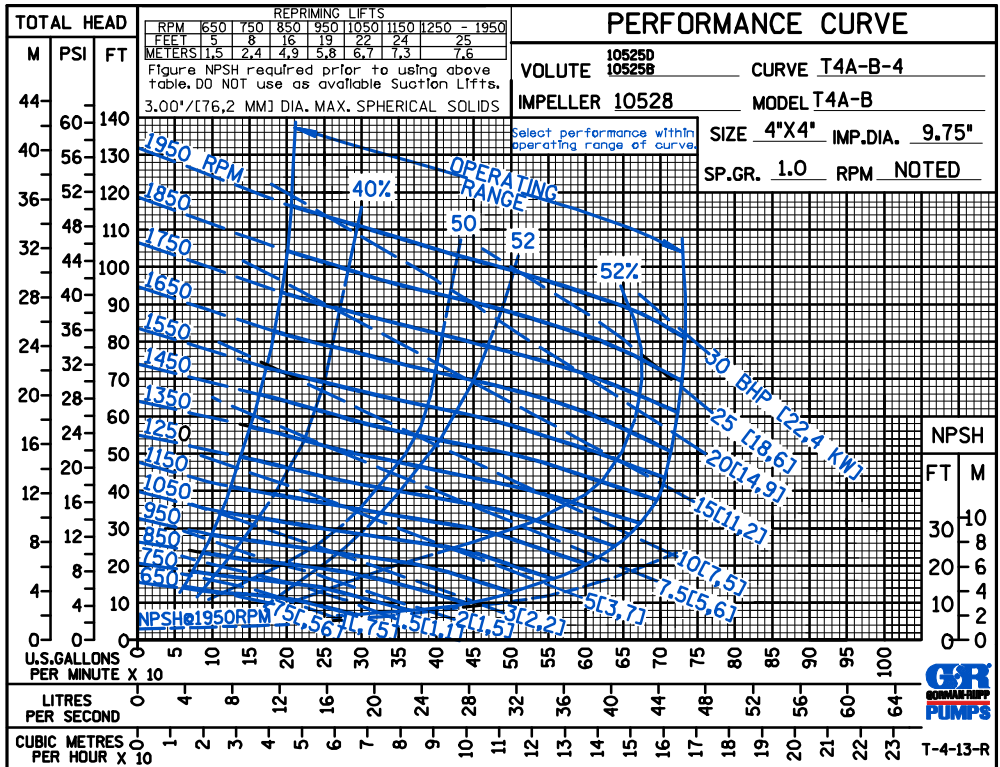

THE GORMAN-RUPP COMPANY • MANSFIELD, OHIO

GORMAN-RUPP OF CANADA LIMITED • ST. THOMAS, ONTARIO, CANADA

Specifications Subject to Change Without Notice

Printed in U.S.A.

CDS

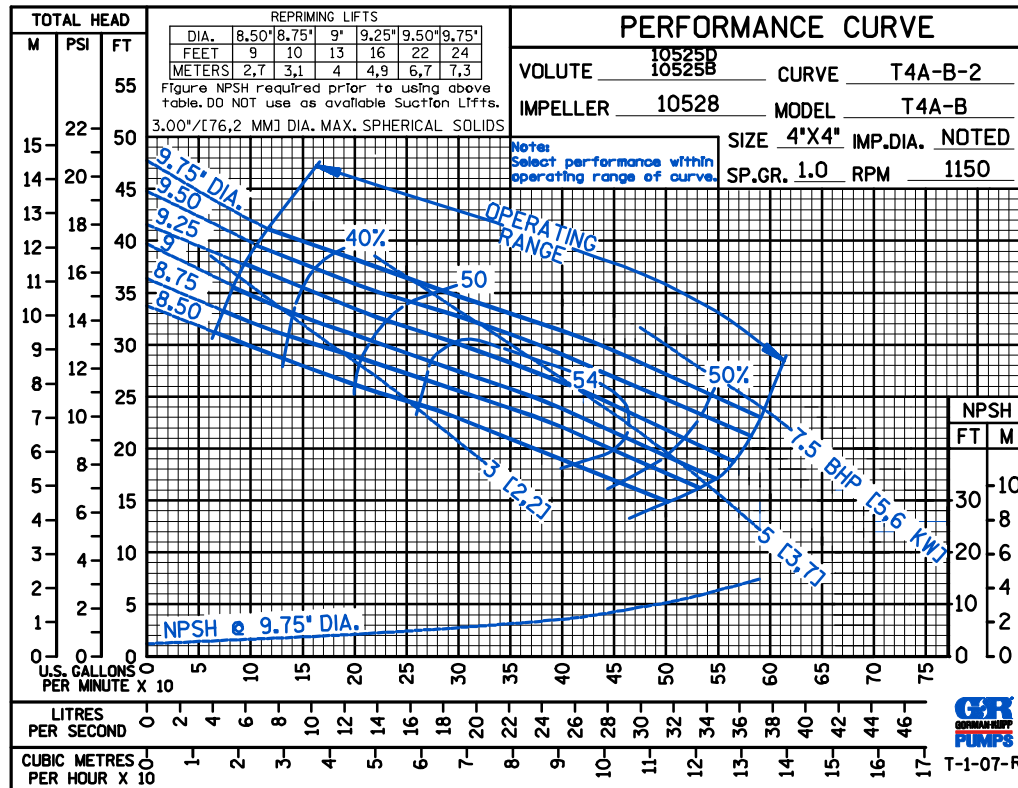
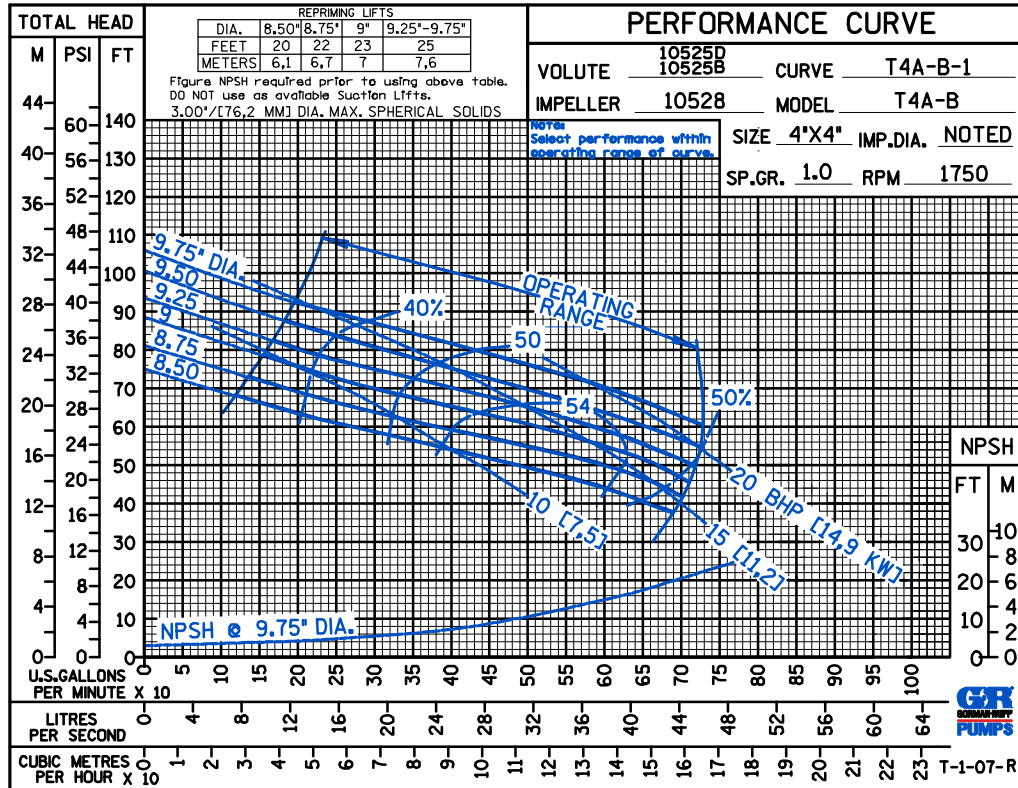

THE GORMAN-RUPP COMPANY • MANSFIELD, OHIO

GORMAN-RUPP OF CANADA LIMITED • ST. THOMAS, ONTARIO, CANADA

Specifications Subject to Change Without Notice

Printed in U.S.A.

CDS

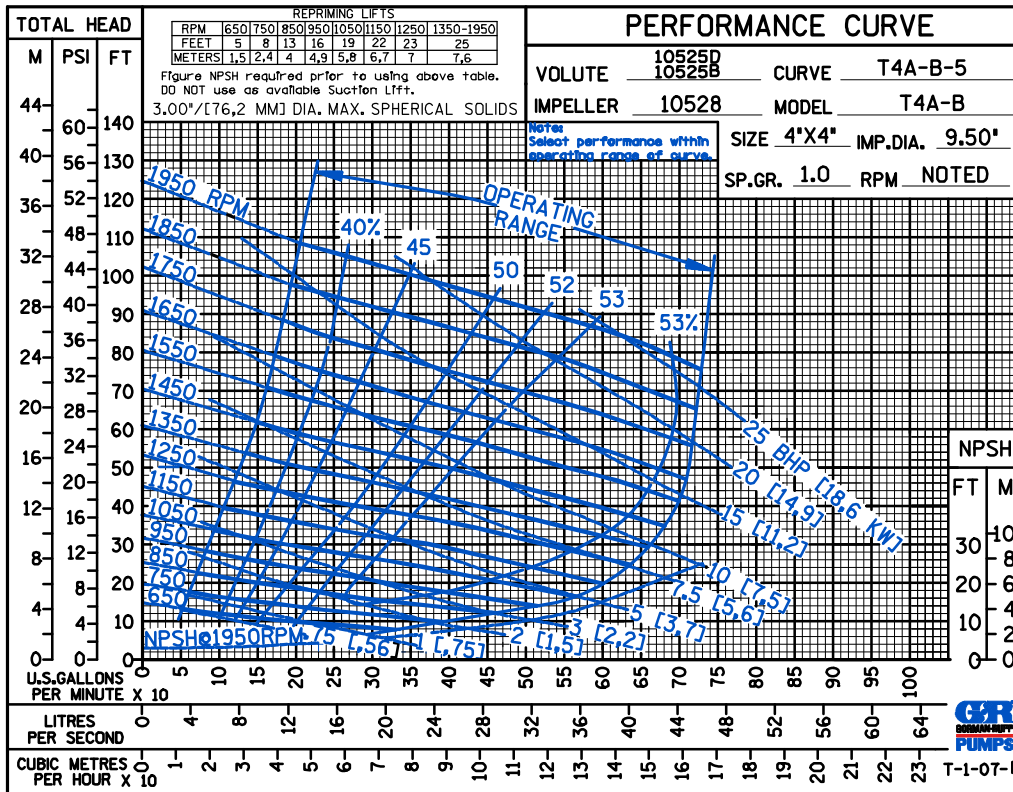
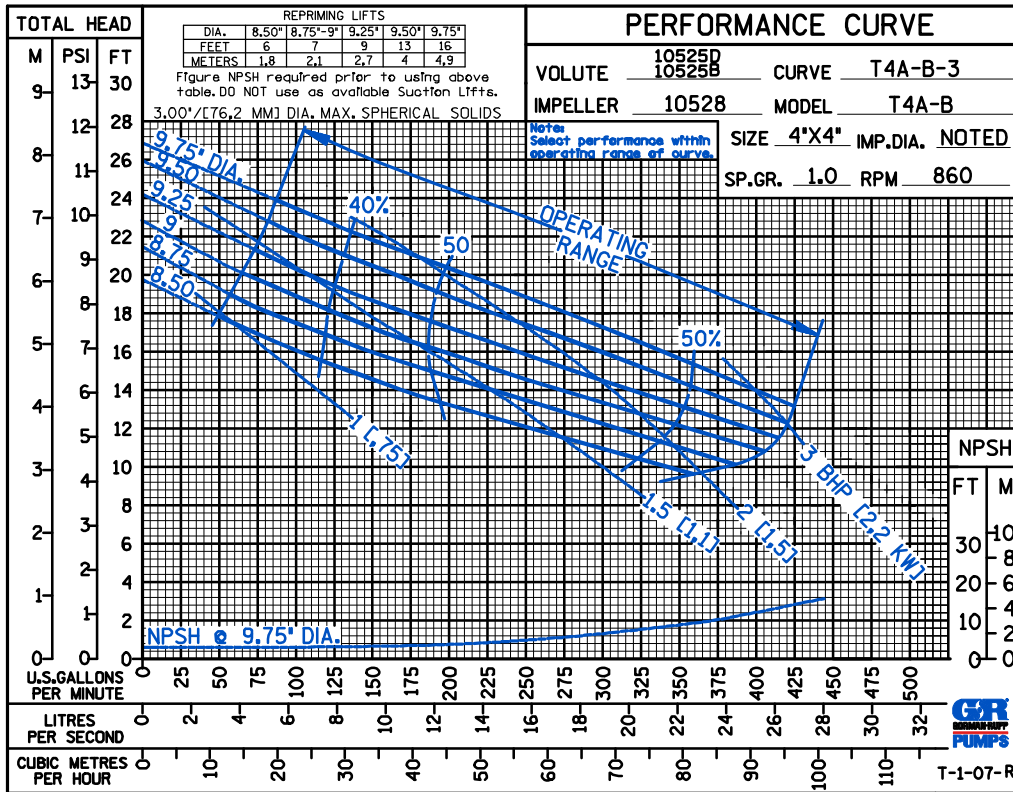

THE GORMAN-RUPP COMPANY • MANSFIELD, OHIO

GORMAN-RUPP OF CANADA LIMITED • ST. THOMAS, ONTARIO, CANADA

Specifications Subject to Change Without Notice

Printed in U.S.A.

CDS

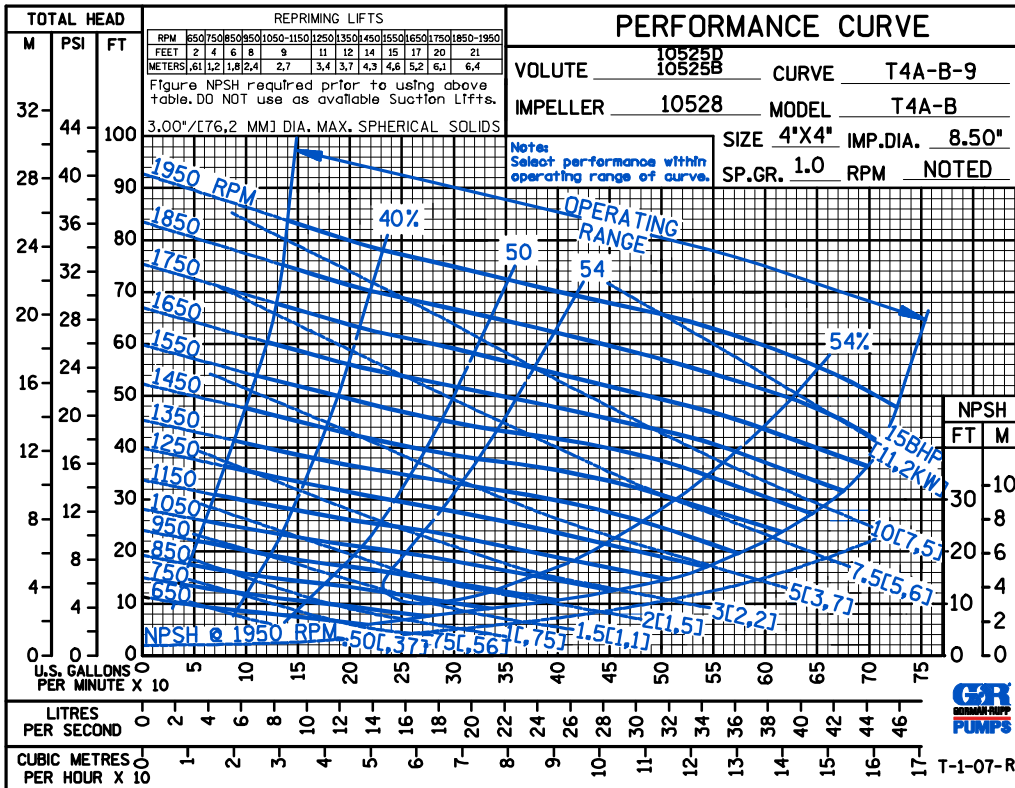
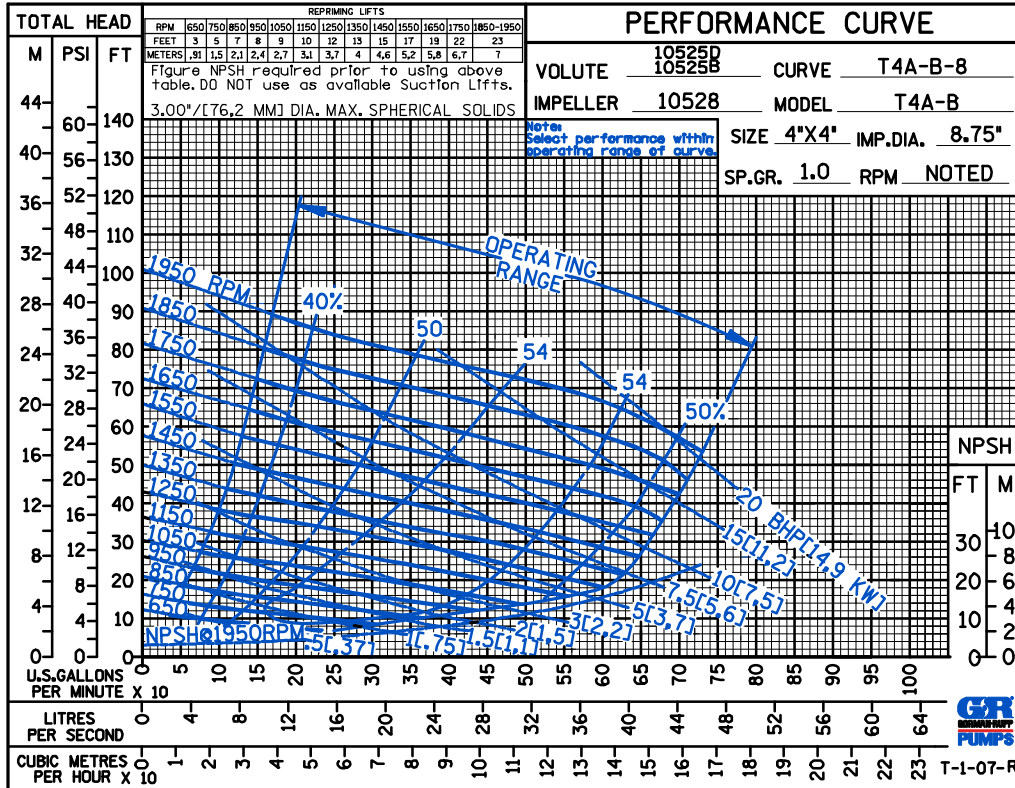

THE GORMAN-RUPP COMPANY • MANSFIELD, OHIO

GORMAN-RUPP OF CANADA LIMITED • ST. THOMAS, ONTARIO, CANADA

Specifications Subject to Change Without Notice

Printed in U.S.A.

CDS

50 HERTZ

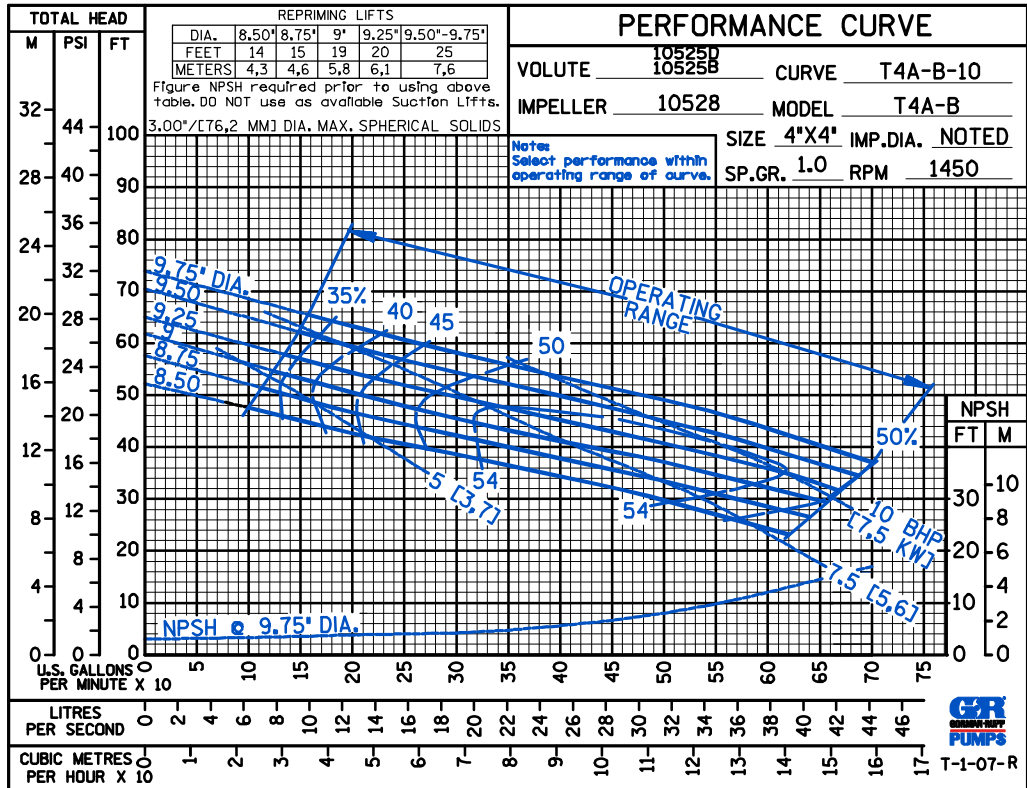

50 HERTZ

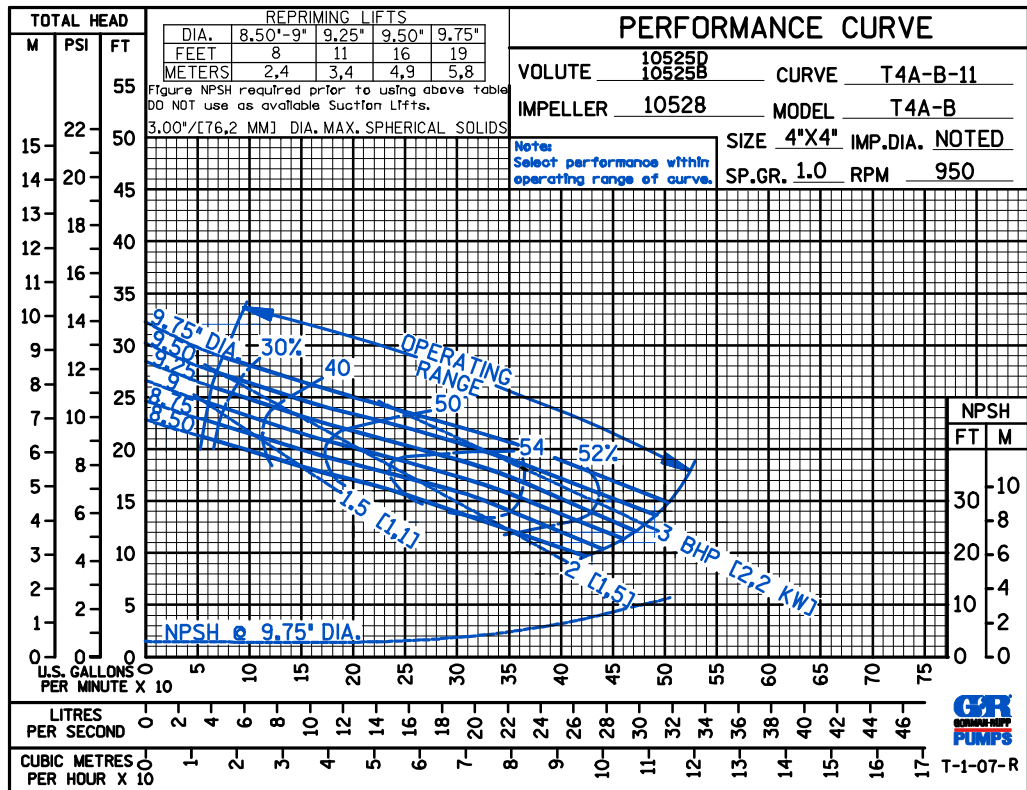

THE GORMAN-RUPP COMPANY • MANSFIELD, OHIO

GORMAN-RUPP OF CANADA LIMITED • ST. THOMAS, ONTARIO, CANADA

Specifications Subject to Change Without Notice

Printed in U.S.A.

D S

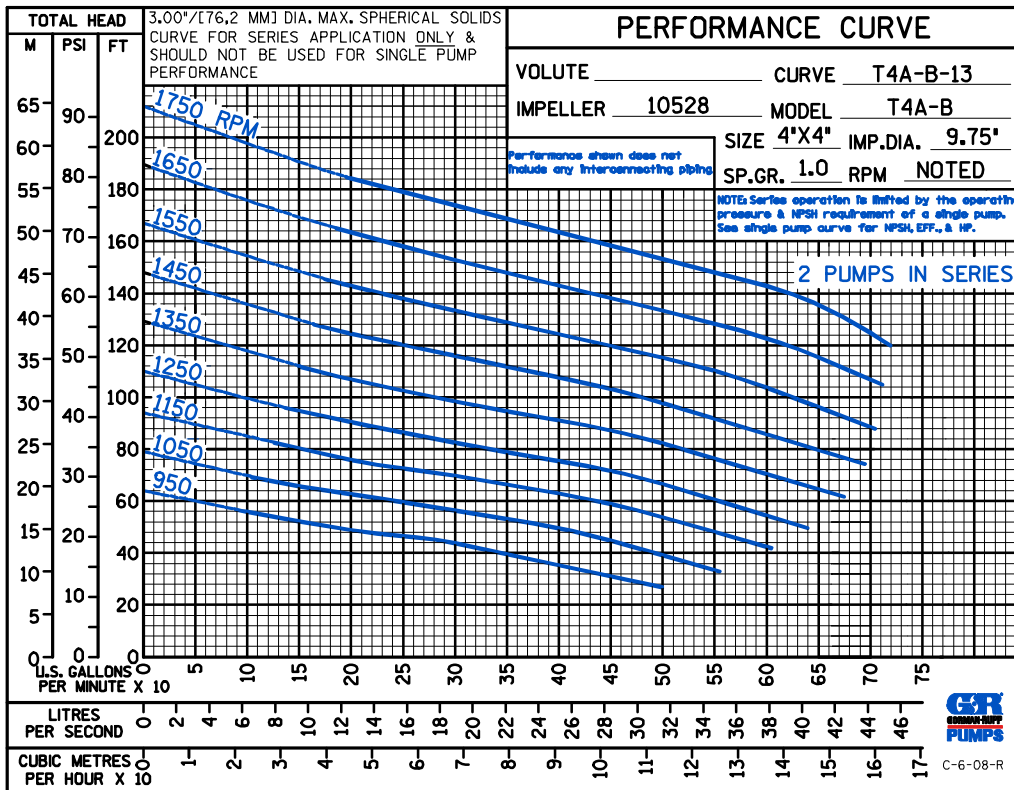
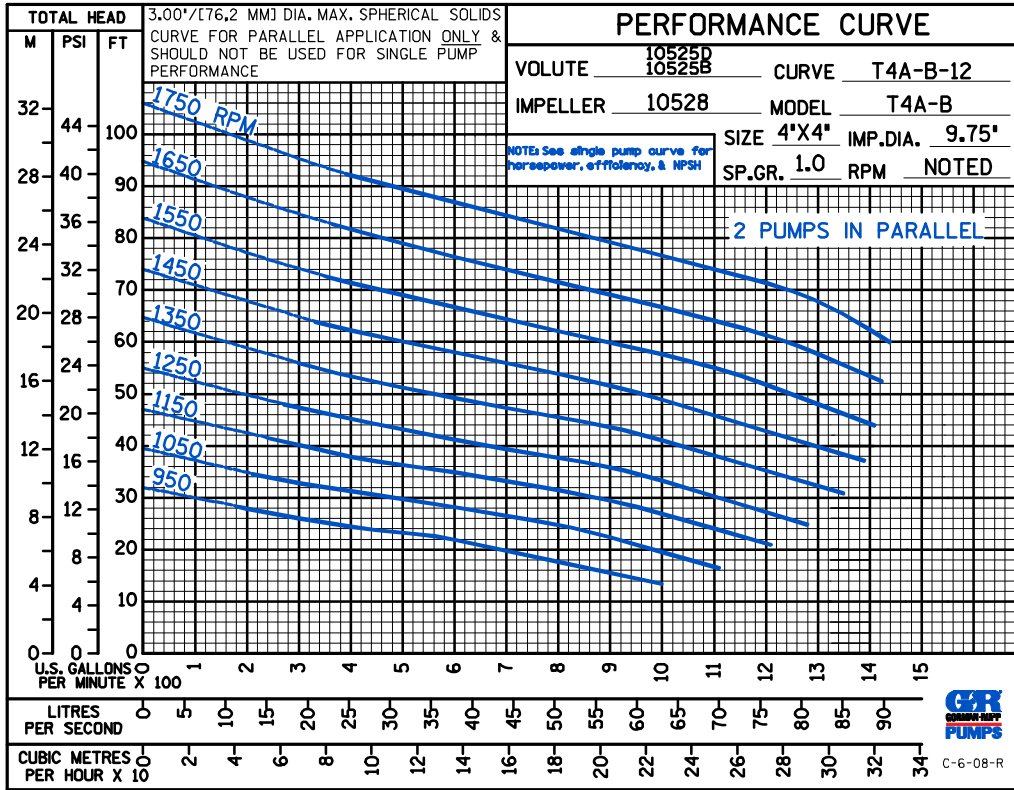

THE GORMAN-RUPP COMPANY • MANSFIELD, OHIO

GORMAN-RUPP OF CANADA LIMITED • ST. THOMAS, ONTARIO, CANADA

Specifications Subject to Change Without Notice

Printed in U.S.A.